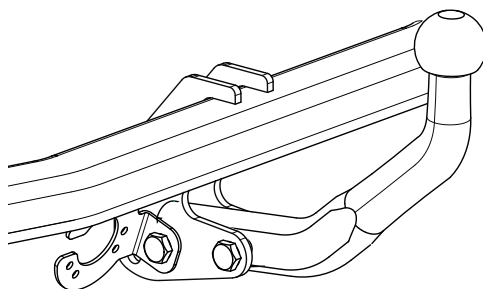

Fitting instructions

Make: Citroën

C4 Picasso

C4 Space tourer; 30/2018->

Type: 5466





- NL Montagehandleiding
- GB Fitting instructions
- D Montageanleitung
- F Instructions de montage
- S Monteringsanvisningar
- DK Montagevejledning
- E Instrucciones de montaje
- I Istruzioni per il montaggio
- PL Instrukcja montażu
- SF Asennusohjeet
- CZ Pokyny k montáži
- H Szerelési útmutató
- RUS Руководство для монтажа

BRiNK[®]

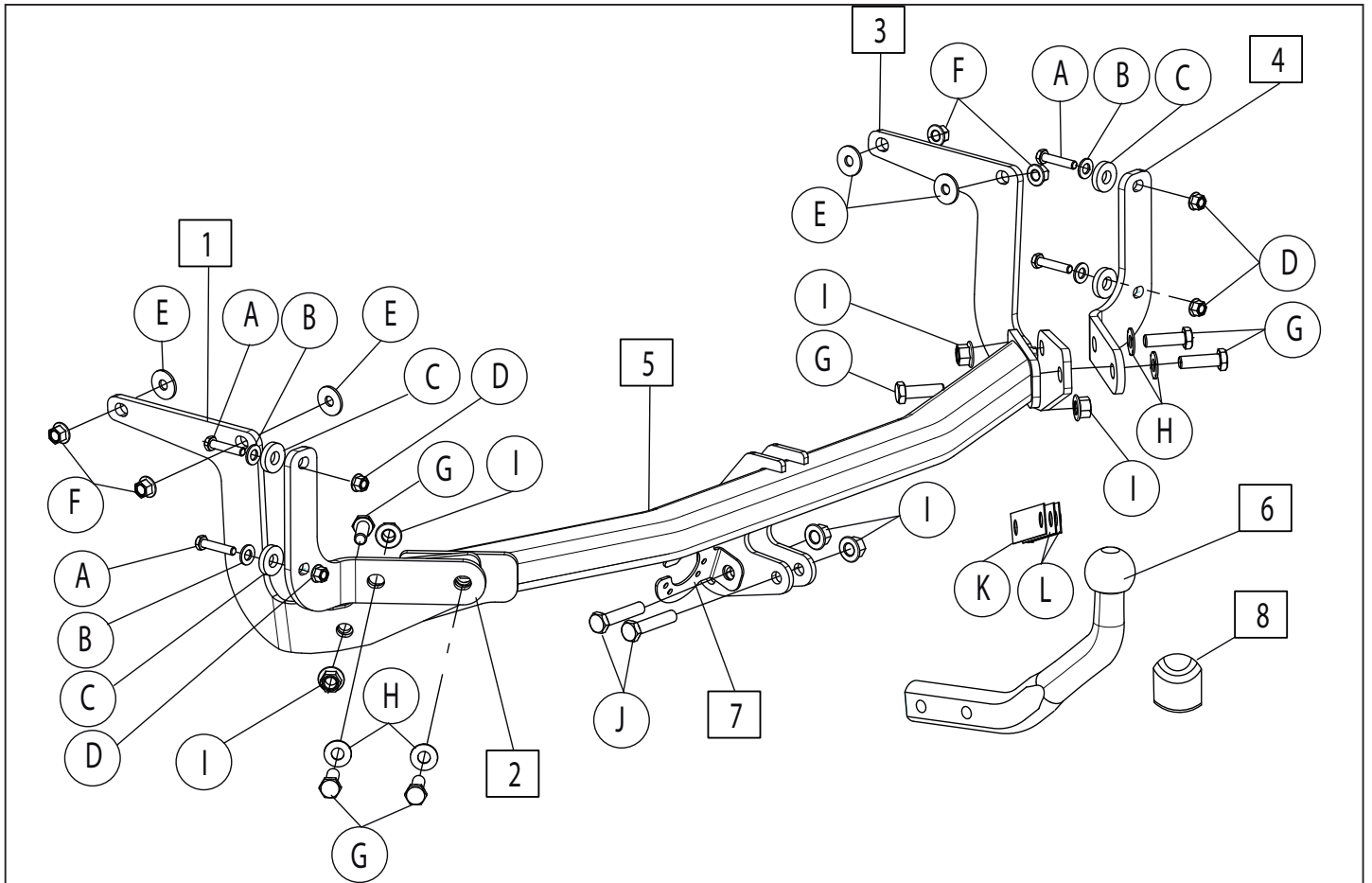
Your perfect fit
brink.eu

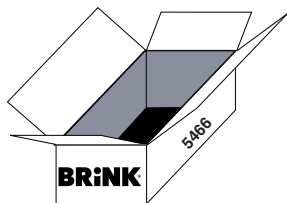



- (A) x4 HM 8x40 cl10.9
- (B) x4 M10 Ø18xØ10.5 x2
- (C) x4 M12 Ø30xØ13x6
- (D) x4 HM8 cl10
- (E) x4 M10 Ø30xØ10.5x2.5
- (F) x4 HM10 cl10
- (G) x6 HM12x40 cl10.9
- (H) x4 M12 Ø27xØ12.5x1.8
- (I) x6 HM12 cl10
- (J) x2 HM12x60 cl10.9
- (K) x1  (1mm)
- (L) x2  (2mm)

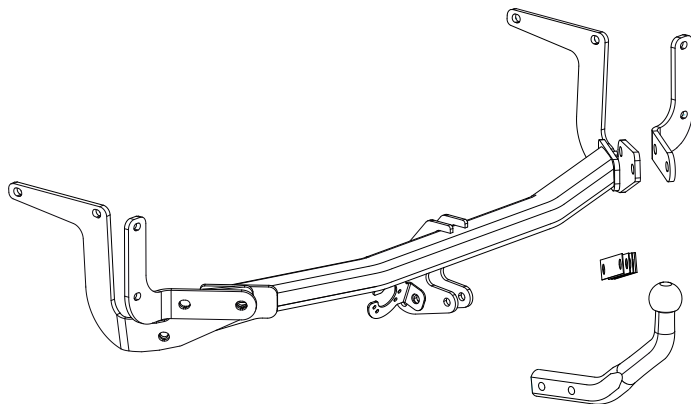

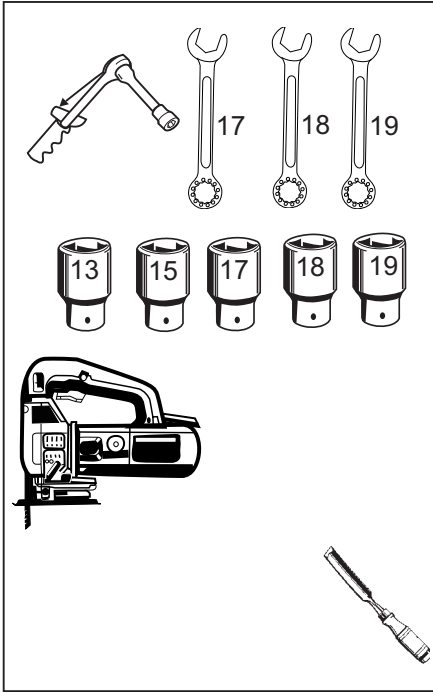

Couplingsclass: A50-X

euro tested

Approved

E11 55R-018358

ECE/R55

D-Value : 9,5 kN

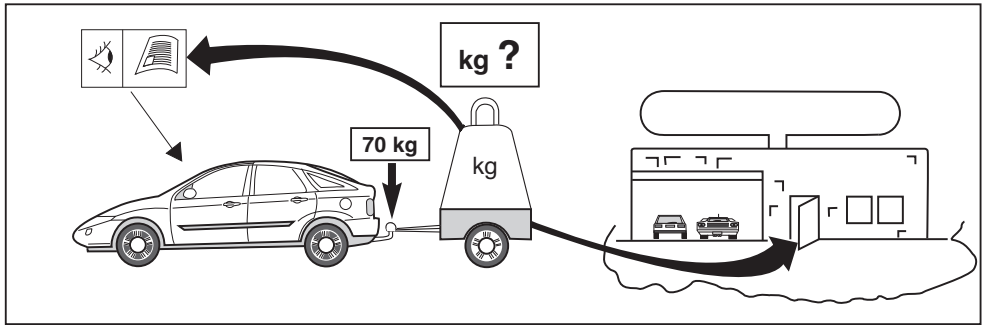

10.9

10

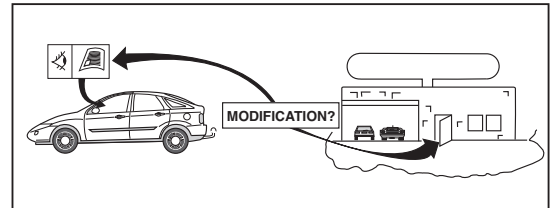



NL.

* Brink is niet aansprakelijk voor de schade die het direct of indirect gevolg is van onjuiste montage, daaronder begrepen gebruik van niet-geschikte gereedschappen en het gebruik van andere dan de voorgeschreven montagewijze en middelen, dan wel onjuiste interpretatie van dit onderhavig montagevoorschrift.

GB.

NOTE:

* **Should this installation process entail the cutting of the bumper – conformation MUST be obtained by the installation engineer of the customer’s acceptance prior to completion. Brink Towing Systems do not accept responsibility for any matters arising as a result of this miscommunication.**

All measurements are in mm!

* Brink is not liable for damage caused directly or indirectly by incorrect assembly, including the use of unsuitable tools, the use of other assembly methods and means than the ones outlined, and the incorrect interpretation of these assembly instructions.

D.

HINWEISE:

* Die für das Fahrzeug zugelassene Anhängelast ist den Fahrzeug Unterlagen zu entnehmen. Bei Änderungen des Fahrzeuggewichtes muß die höchstzulässige Anhängelast gegebenenfalls aus dem D-Wert nachgerechnet werden.

Auskunft hierüber kann Ihr Fachhändler oder der TÜV geben.

* Elektrische Anlage gemäß StVZO anbringen.

* Brink haftet nicht für Schäden, die als direkte oder indirekte Folge einer nicht ordnungsgemäßen Montage auftreten, darunter fallen auch die Benutzung von ungeeigneten Werkzeugen, andere als die vorgeschriebenen Montageverfahren und Montagemittel sowie eine fehlerhafte Interpretation der betreffenden Montageanweisung.

F.

* Brink décline toute responsabilité pour les dommages qui pourraient directement ou indirectement résulter d’un montage incorrect, y compris l’utilisation d’outils inappropriés et l’utilisation d’un mode d’emploi et de moyens autres que ceux prescrits, ou bien résulter d’une interprétation inexacte des présentes instructions de montage.

S.

* Brink är inte ansvariga för skada som orsakats direkt eller indirekt av felaktig montering, inklusive användning av olämpliga verktyg, andra monteringsmetoder och processer än de som beskrivs, samt felaktig tolkning av dessa monteringsinstruktioner.

DK.

* Brink er ikke ansvarlig for skade der direkte eller indirekte er forårsaget af forkert montage, herunder også iberegnet brug af forkert værktøj og anvendelse af anden montage metode og andre montage midler end de foreskrevne samt fejltolkning af den medfølgende montagevejledning.

E.

* Brink no se responsabiliza por daños causados, directa o indirectamente, por un montaje incorrecto, incluyendo el uso de herramientas inadecuadas, por el uso de métodos de montaje y medios distintos a los indicados y por la interpretación incorrecta de estas instrucciones de montaje.

I.

* Brink non può essere ritenuta responsabile per eventuali danni direttamente o indirettamente dovuti ad un errato montaggio, intendendo con ciò anche l’uso di attrezzi non idonei e l’uso di metodi e mezzi di montaggio diversi da quelli prescritti, nonché all’errata interpretazione delle seguenti istruzioni di montaggio.

PL.

* Firma Brink nie ponosi odpowiedzialności za straty poniesione pośrednio lub bezpośrednio na skutek niewłaściwego montażu, w tym użycia

niewłaściwych narzędzi i sposobów montażu niezgodnych z instrukcją, oraz niezastosowanie się do treści instrukcji.

SF.

* Brink ei ole vastuussa vioittumisesta, joka on suoraan tai epäsuoraan aiheutunut väärästä asennuksesta samoin kuin sopimattomien työkalujen käytöstä, muiden kuin ohjeissa mainittujen asennusmenetelmien tai välineiden käytöstä sekä kyseisten asennusohjeiden väärintulkinnasta.

CZ.

* Společnost Brink neodpovídá za přímé ani nepřímé škody způsobené nesprávnou montáží, včetně použití nevhodných nástrojů, použití jiných metod montáže a prostředků než uvedených a nesprávným pochoopením těchto pokynů k montáži.

H.

* A Brink nem vállal felelősséget a nem megfelelő szerelésből közvetlen vagy közvetett módon következő károkért. Ez vonatkozik a nem megfelelő szerszámok használatára, a leírtaktól eltérő módszerek és eszközök alkalmazására, valamint a szerelési útmutató téves értelmezésére.

RUS.

* Фирма Brink не отвечает за ущерб, являющийся прямым или косвенным следствием неправильного монтажа, в том числе использования неподходящих инструментов и применения иного способа монтажа или других средств, чем предписано в инструкции, либо неправильного истолкования настоящей инструкции по монтажу.

Copy of manufacturersplate

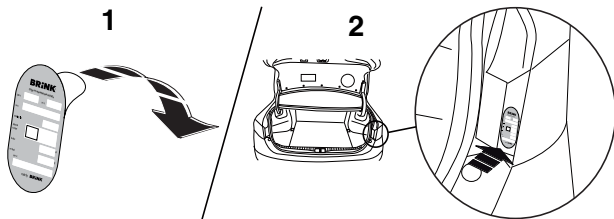

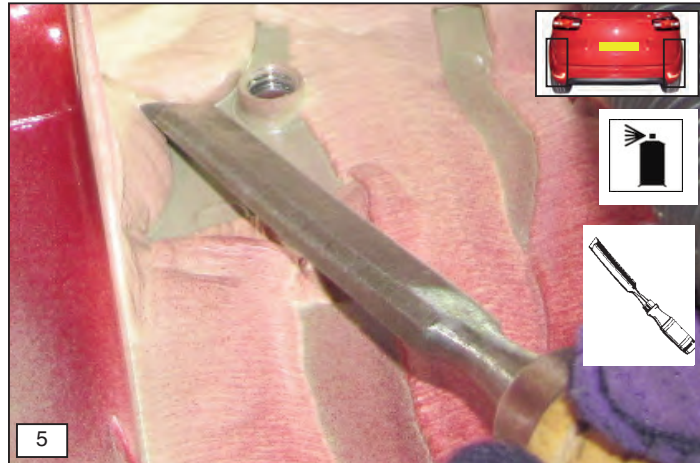
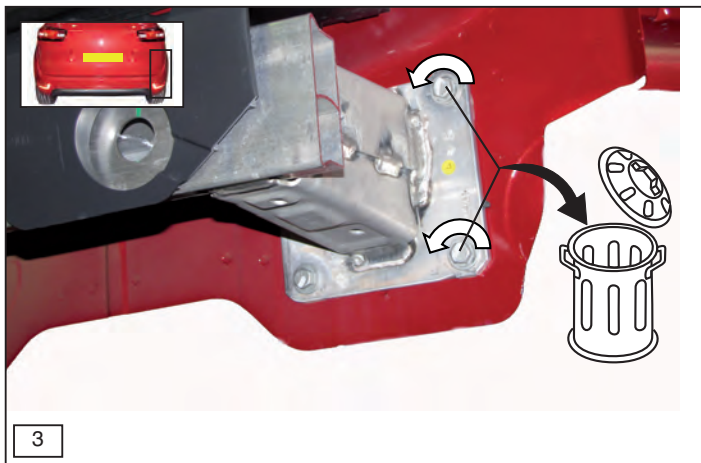
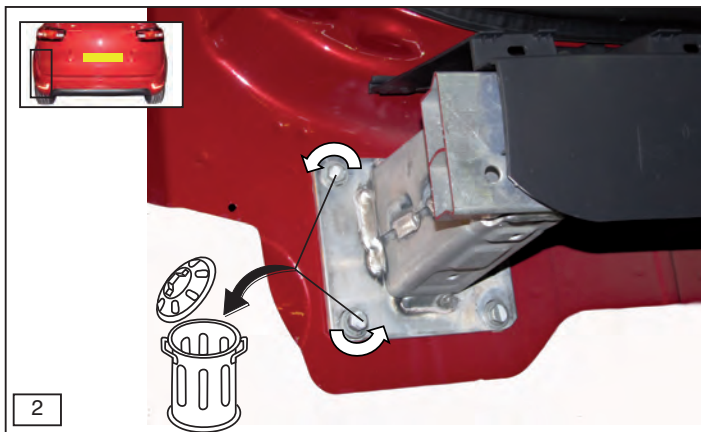

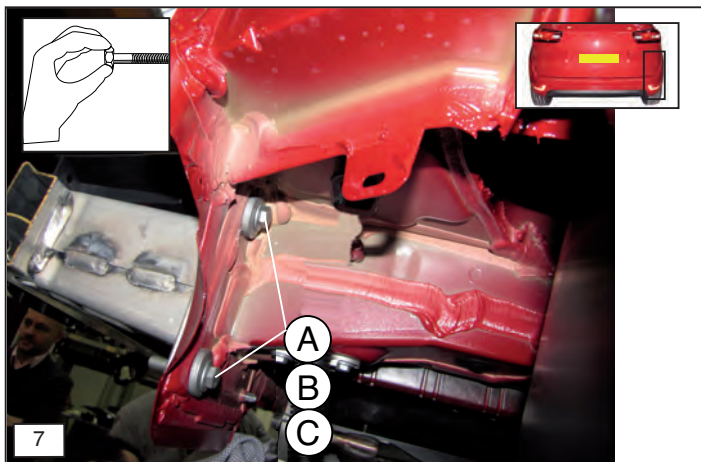
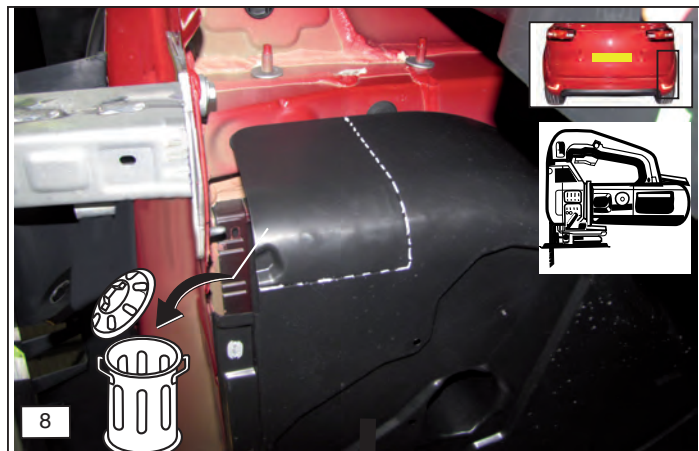
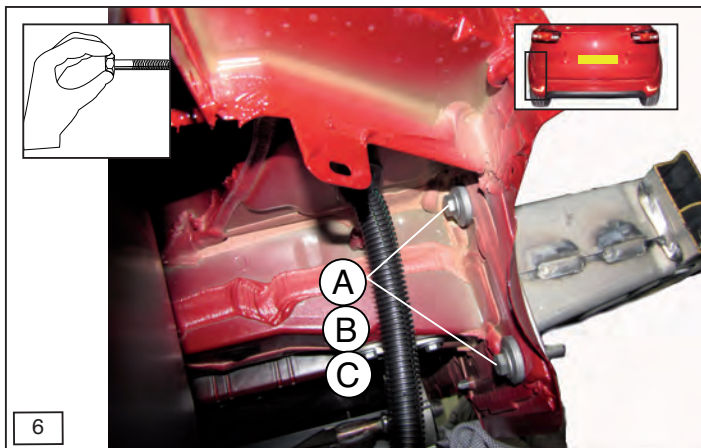

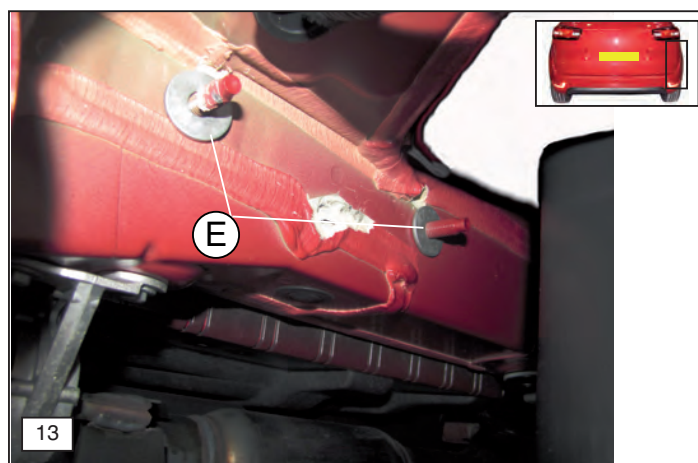
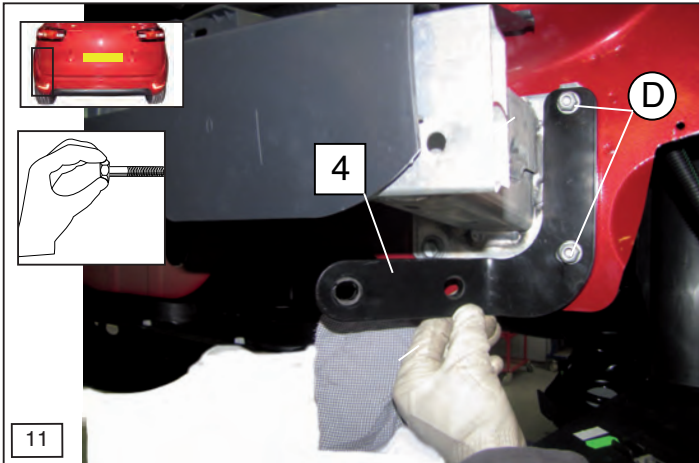
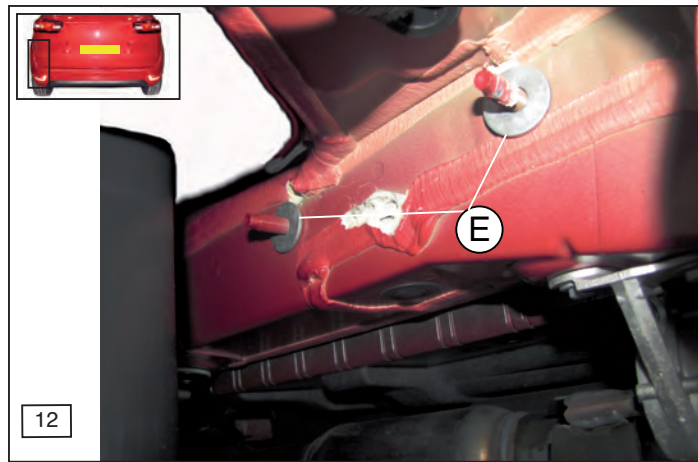
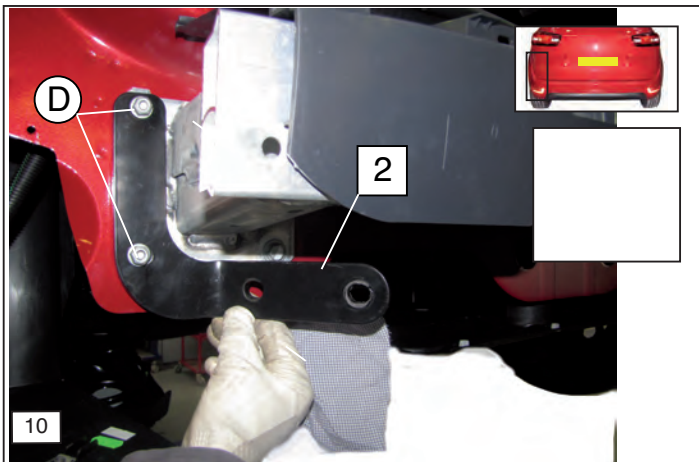

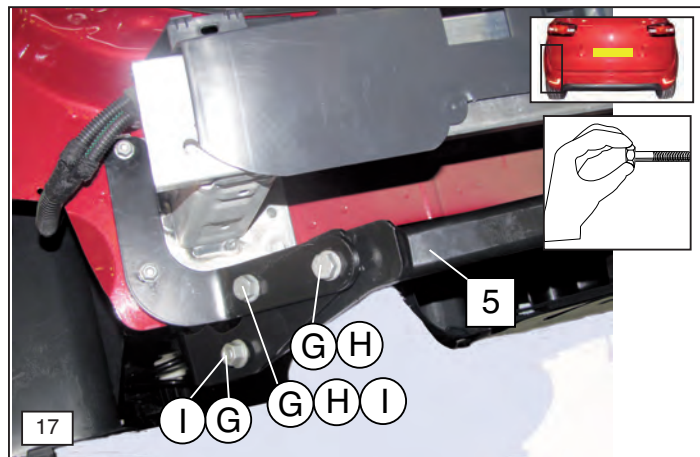
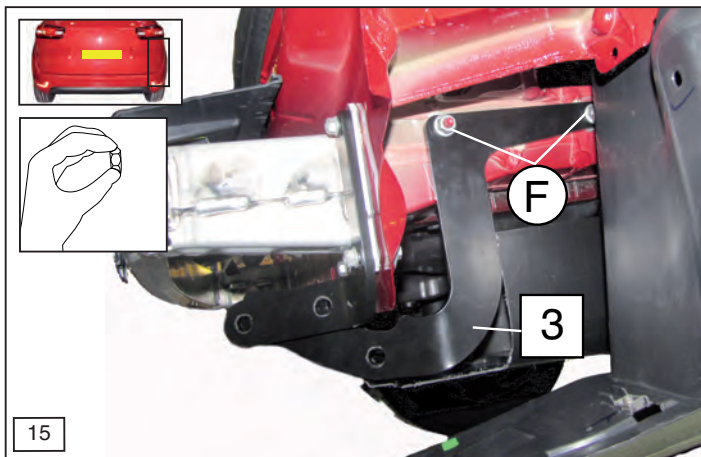
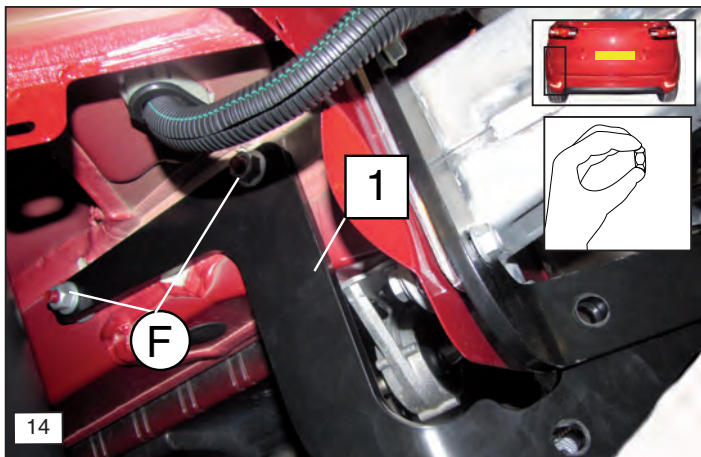

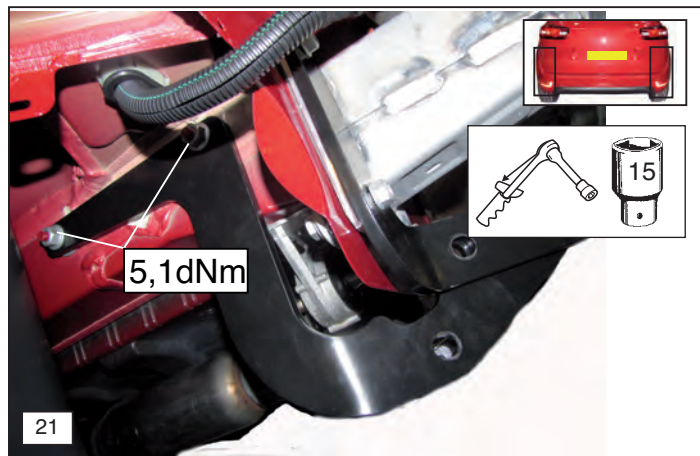
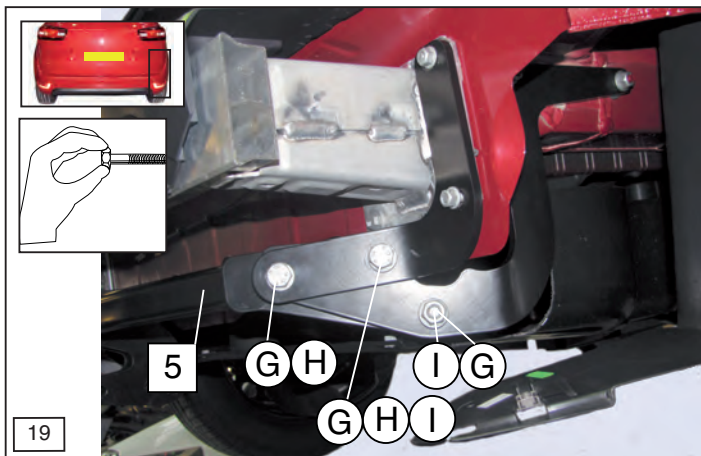
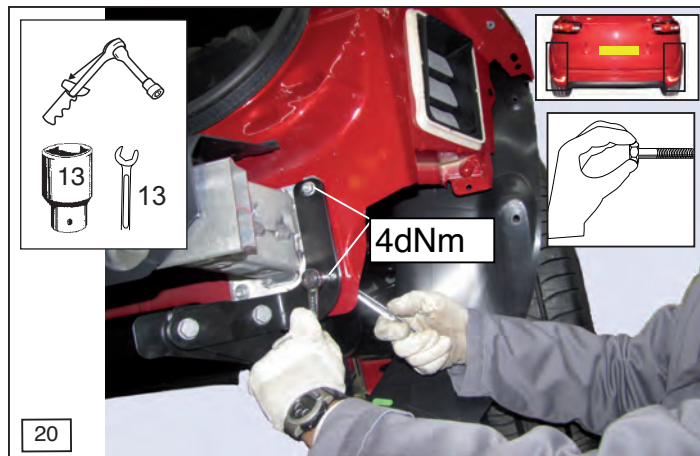
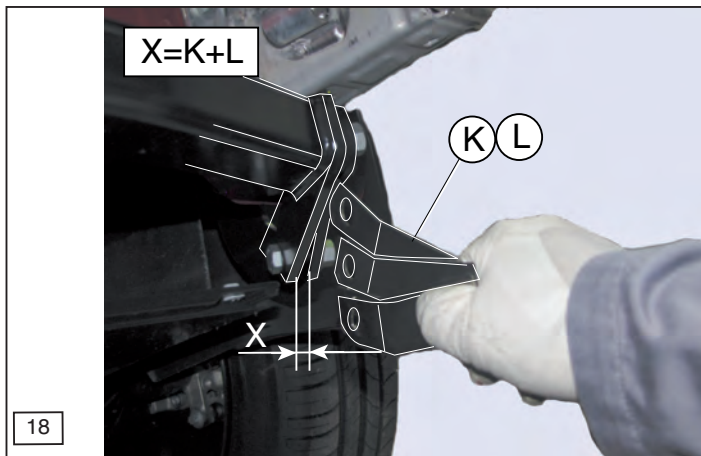

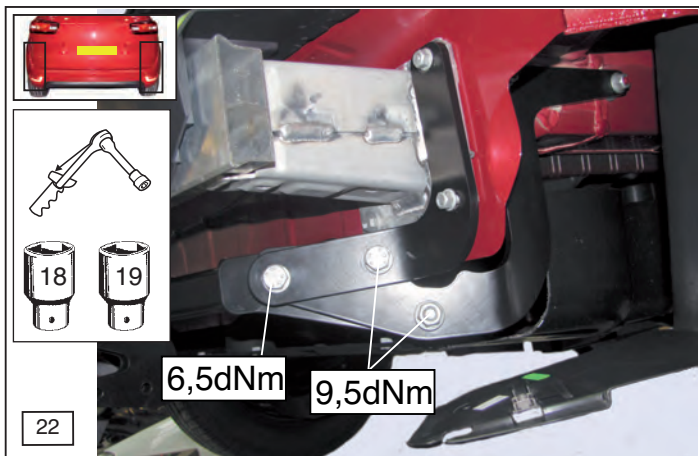

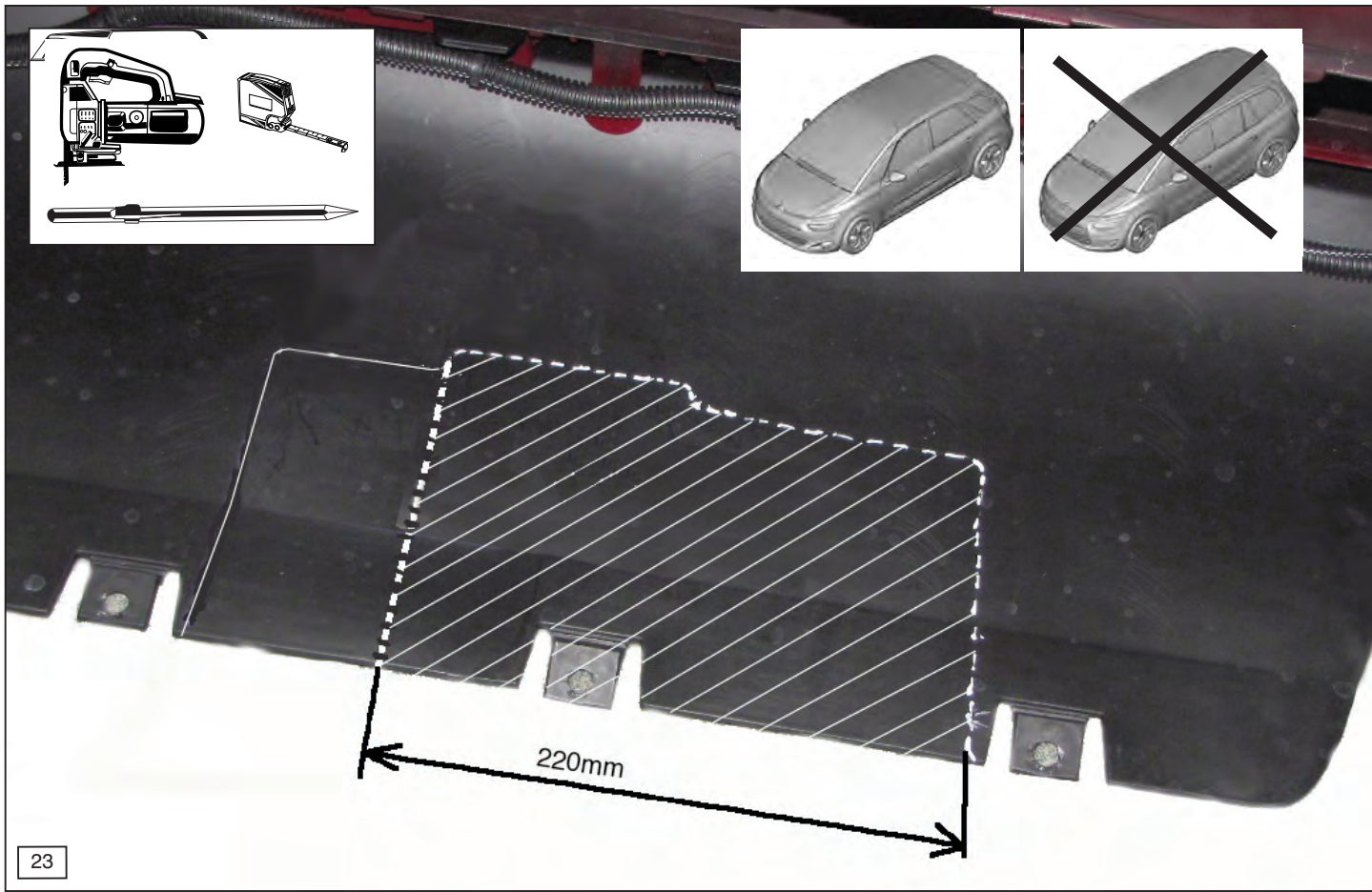
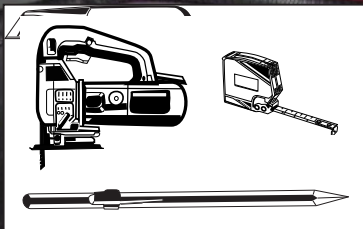

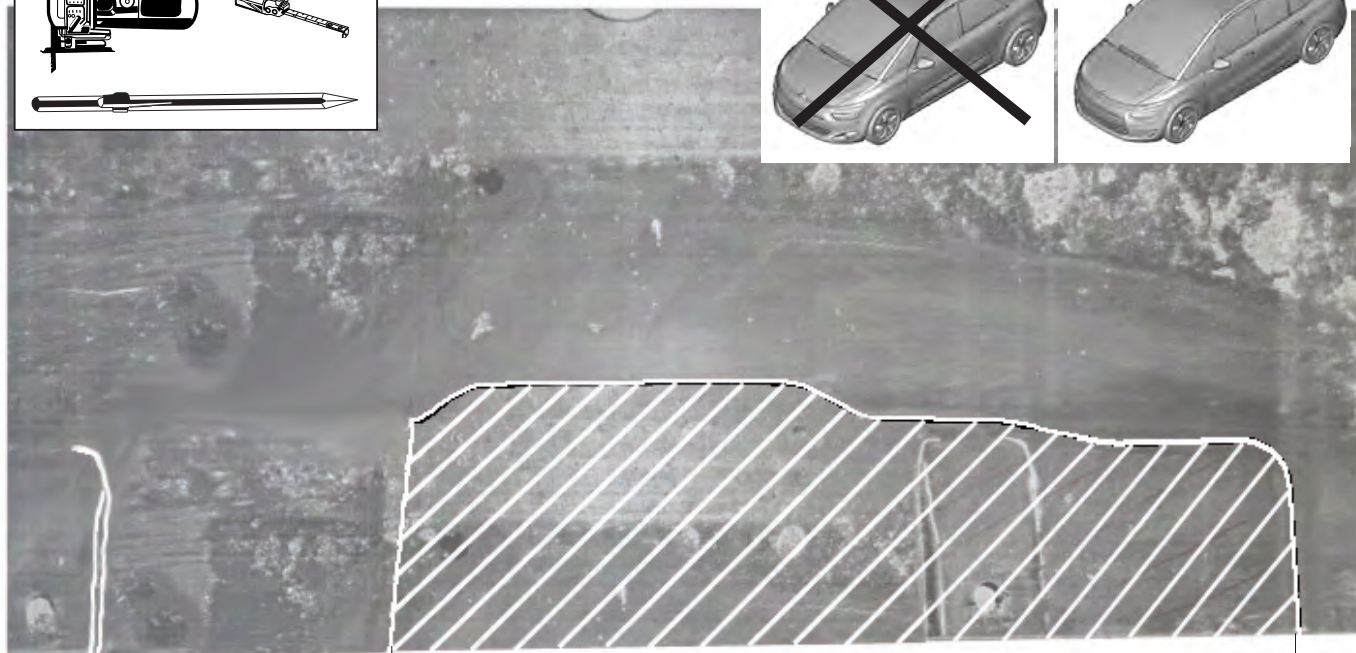
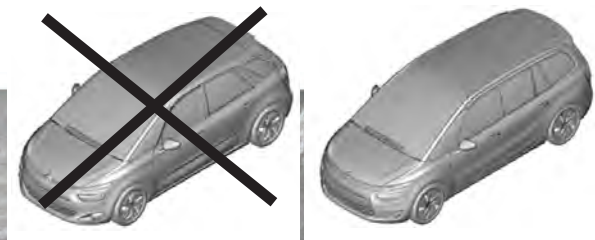
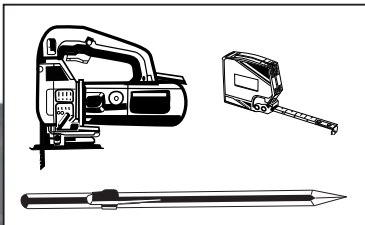

← 220mm →

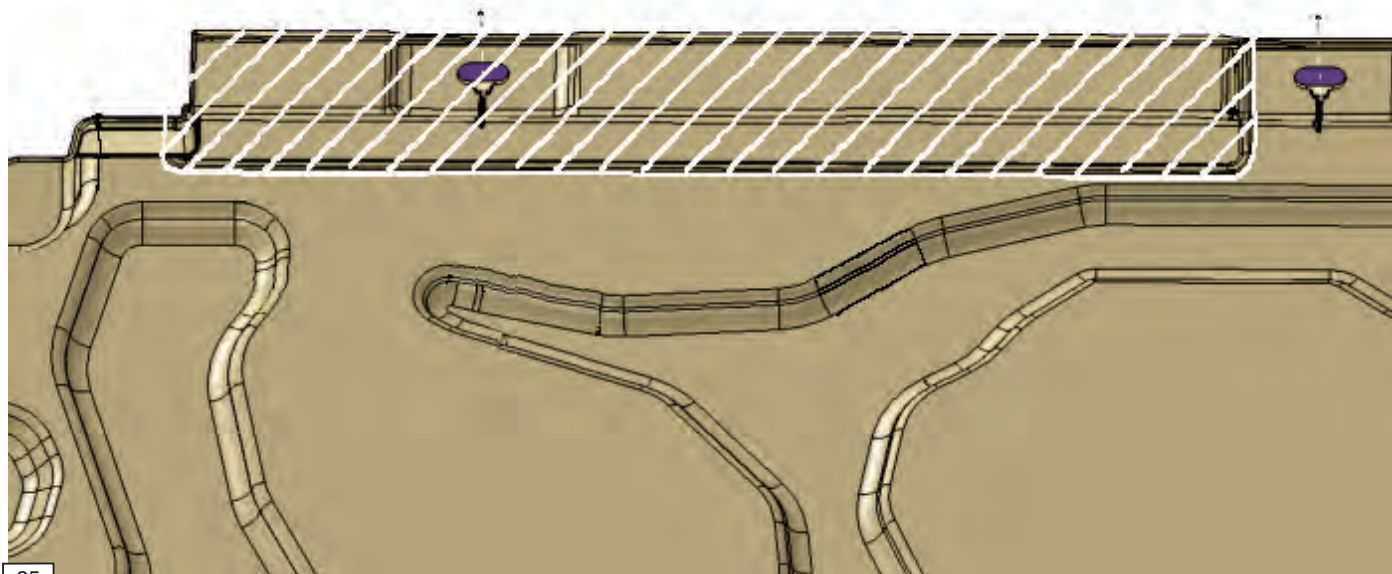
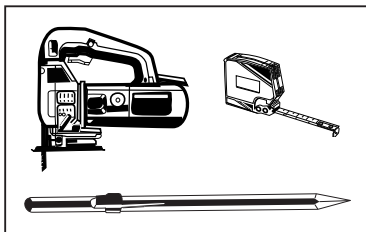

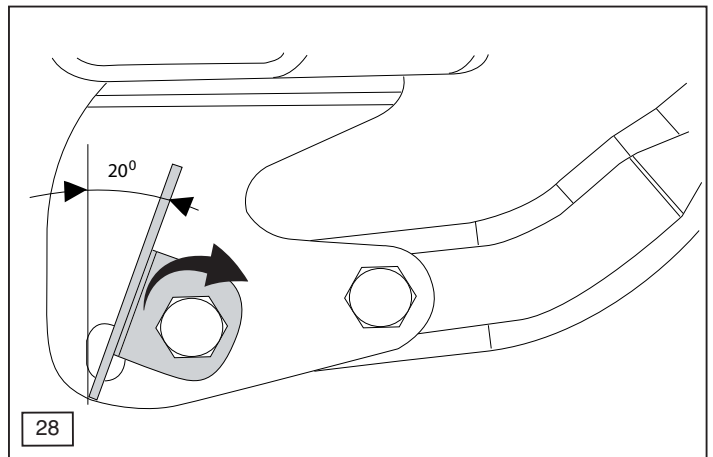
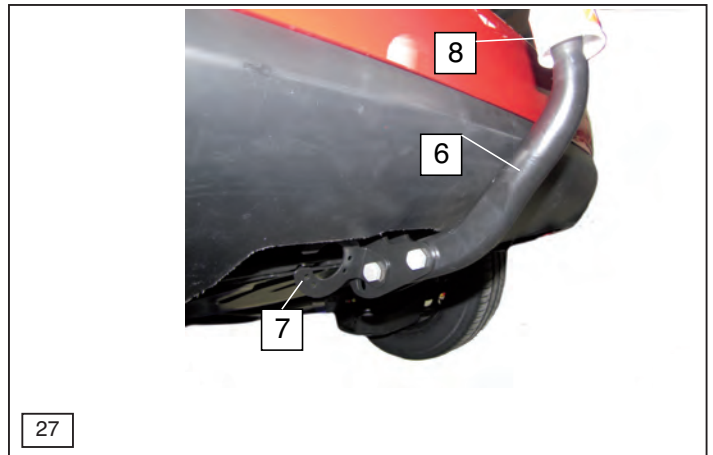

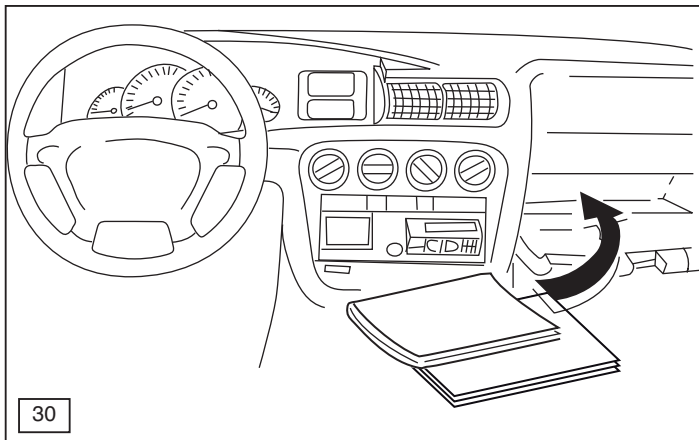
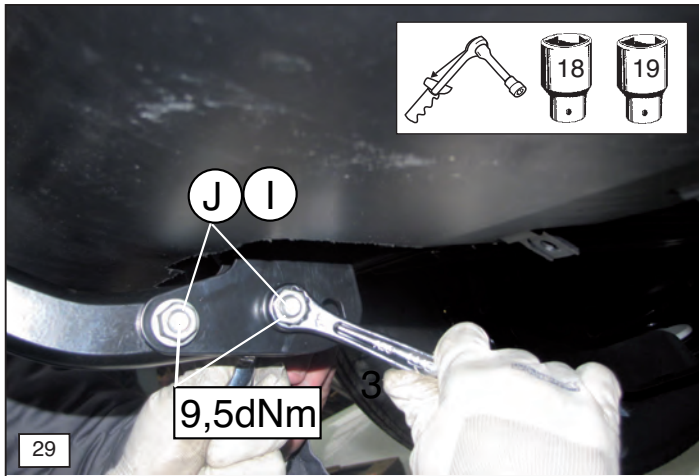



Dispositivo di traino tipo: 5466
Per autoveicoli: Citroën C4 Picasso
Tipo funzionale: 3 A**** / * , 3 A**** / ** , 3 A**** / ***
3 D**** / * , 3 D**** / ** , 3 D**** / *** ,
3 E**** / * , 3 E**** / ** , 3 E**** / *** ,

Classe e tipo di attacco: A50-X
Omologazione: E11 55R 018358
Valore D: 9,5 kN
Carico Verticale max. S: 70 kg

Larghezza rimorchiabile per Caravan e T.A.T.S.: 2,55m vedere CARTA di CIRCOLAZIONE VEICOLO (motrice) + 70 cm = ..arrotondare ai 5 cm superiore (vedi D.M.28/05/125)

Massa rimorchiabile: vedi carta di circolazione dell' autoveicolo

Per verificare l' idoneità del dispositivo di traino omologato a norma ECE/R55, all' installazione sulla vettura su cui si intende procedere al montaggio, compilare la seguente formula (se necessario declassare la massa rimorchiabile):

$$D = \frac{T \times C}{T + C} \times 0,00981 \leq 9,5 \text{ kN}$$

dove: T= Massa Complessiva Max. della motrice (in kg)
C= Massa Rimorchiabile Max. della motrice (in kg)

DA COMPILARE PER IL COLLAUDO

DICHIARAZIONE DI CORRETTO MONTAGGIO: la sottoscritta Ditta dichiara di aver montato in maniera corretta ed in conformità/ alle prescrizioni sia del costruttore del veicolo che del costruttore del dispositivo stesso il seguente dispositivo di attacco meccanico:

tipo:.....
Il dispositivo di attacco sopra indicato è stato installato su autoveicolo
modello:.....
targa:.....
Data:.....

TIMBRO e FIRMA

Si dichiara inoltre di aver informato l'utente del veicolo sull'USO e MANUTENZIONE del dispositivo stesso.