

Wiringkit

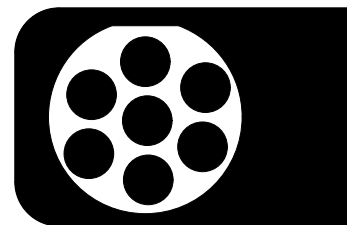

- D Einbauanleitung
- GB Installation instructions
- F Consignes de montage
- NL Montagehandleiding
- DK Montagevejledning
- N Monteringsinstruksjon
- S Installationsanvisning
- FIN Asennusohje
- I Istruzioni per il montaggio
- E Instrucciones de montaje
- P Instruções de montagem
- GR Οδηγίες εγκατάστασης
- CZ Návod k montáži
- SLO Navodilo za vgradnjo
- SK Montážny návod
- PL Instrukcja montażu
- TR Montaj talimatı
- H Beépítési útmutató
- HR Upute o ugradnji
- BUL Инструкция за монтаж
- RO Instrucțiuni de montaj
- RU Инструкция по монтажу и установке
- LT Montavimo informacija
- LV Iemontēšanas pamācība
- EST Paigaldusjuhend

703323

BMW

- **3-Serie Limousine/Saloon E90** 03/05 >> 02/12
- **3-Serie Touring E91** 09/05 >> 08/12
- **3-Serie Coupé E92** 09/06 >> 09/13
- **3-Serie Cabrio E93** 03/07 >> 02/14

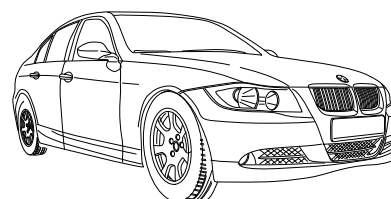
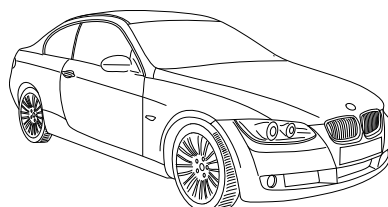
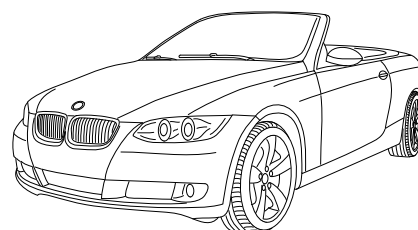
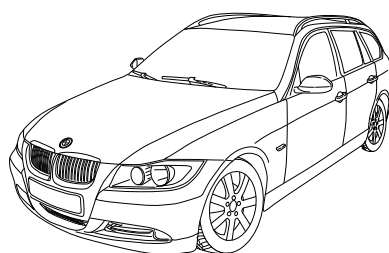

KIT

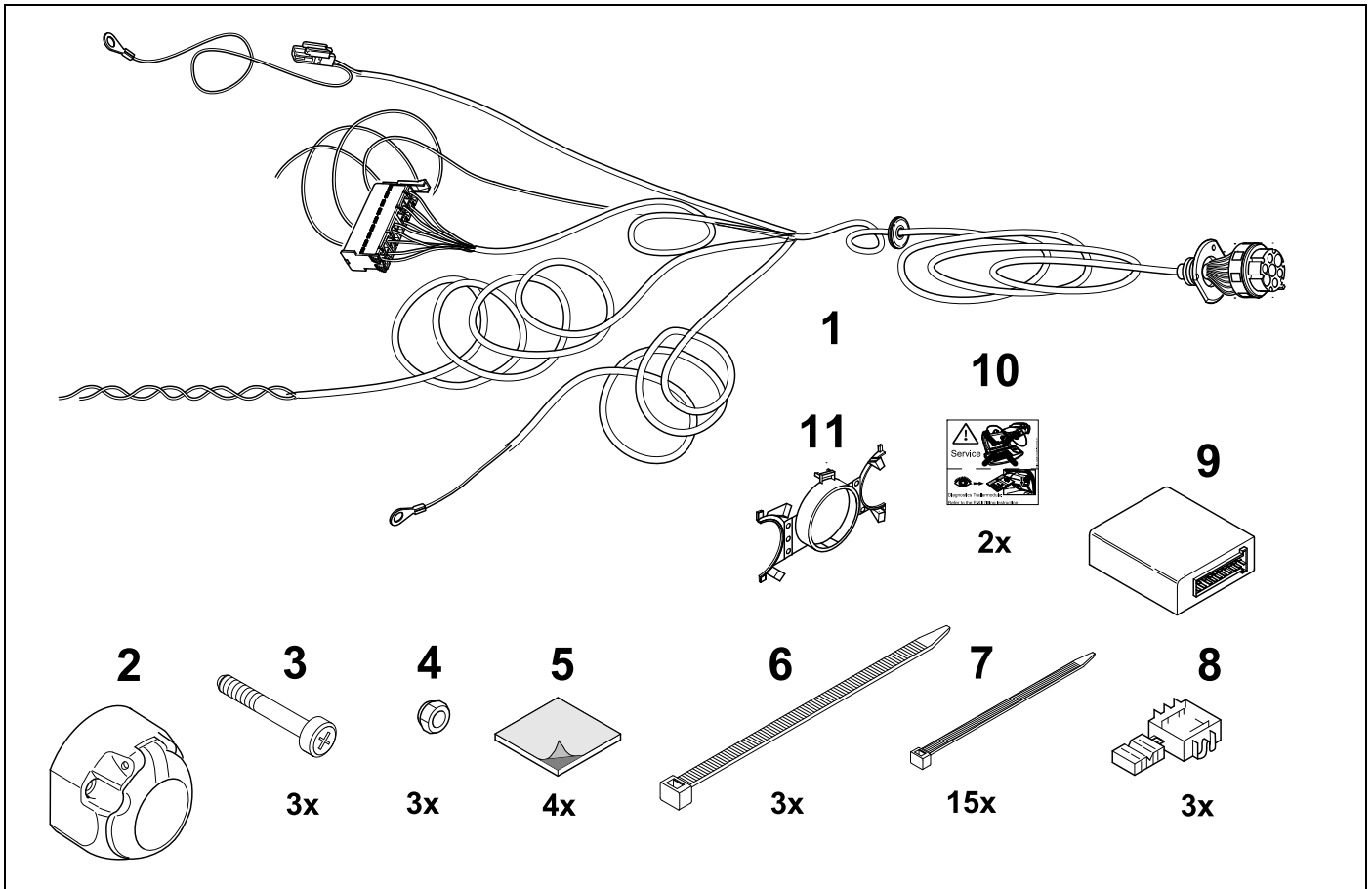

TOOLS

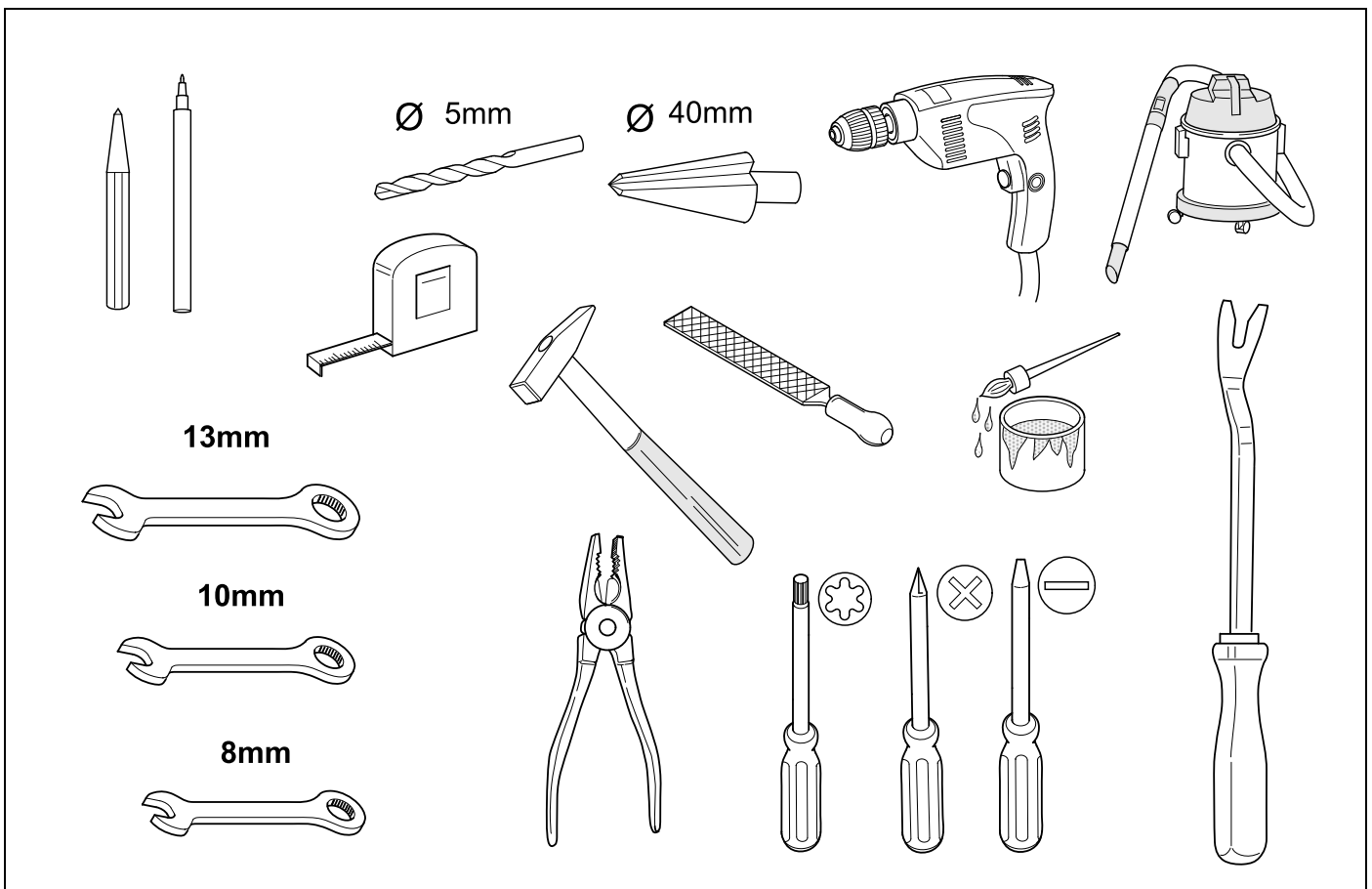

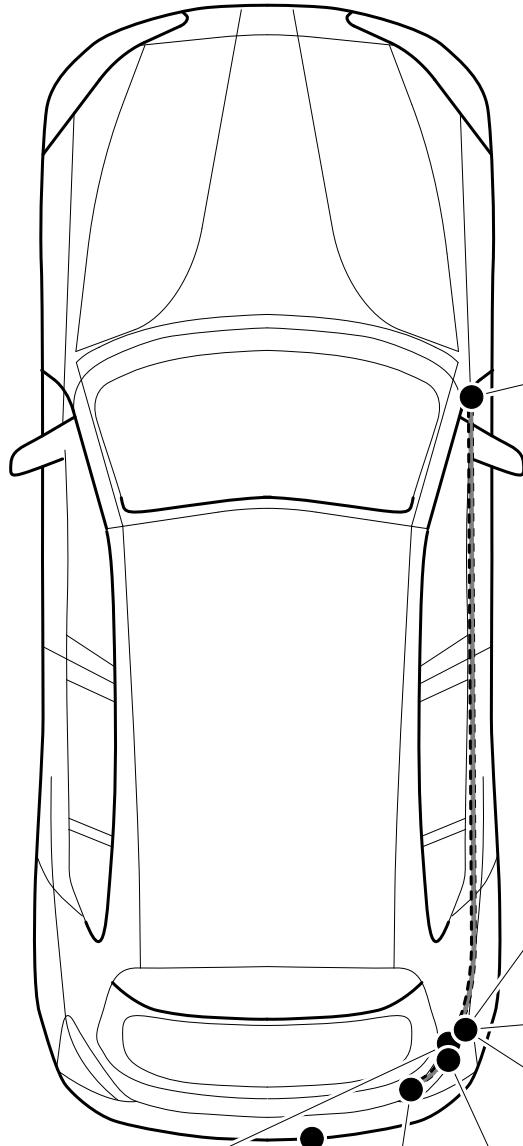



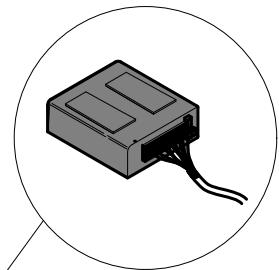
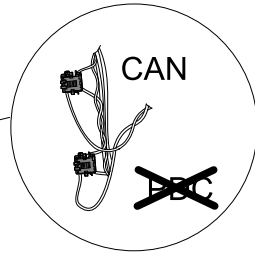



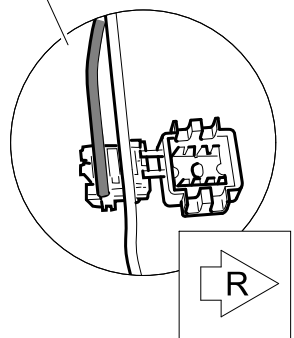
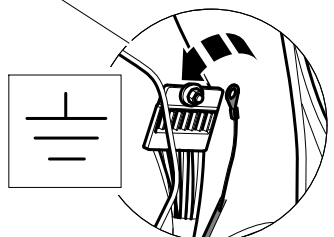
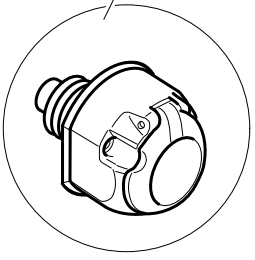
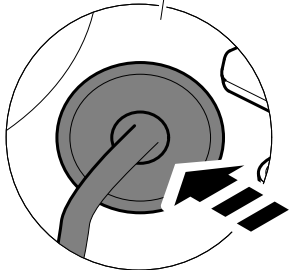
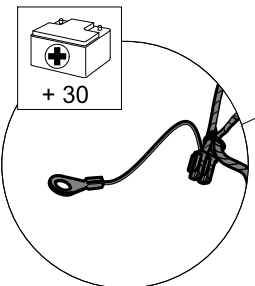
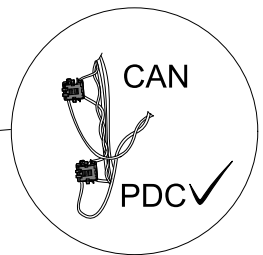

OPTION 2



OPTION 1

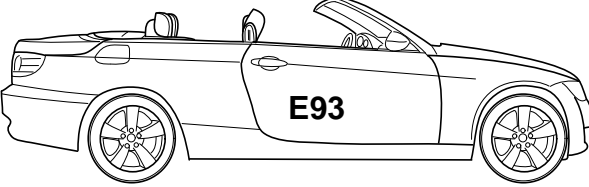

OVERVIEW

			<table border="1"><tr><td>1</td><td>-</td><td>9</td></tr><tr><td>26</td><td>-</td><td>43</td></tr></table>	1	-	9	26	-	43
1	-	9							
26	-	43							
			<table border="1"><tr><td>1</td><td>-</td><td>17</td></tr><tr><td>26</td><td>-</td><td>43</td></tr></table>	1	-	17	26	-	43
1	-	17							
26	-	43							
			<table border="1"><tr><td>1</td><td>-</td><td>43</td></tr></table>	1	-	43			
1	-	43							

1

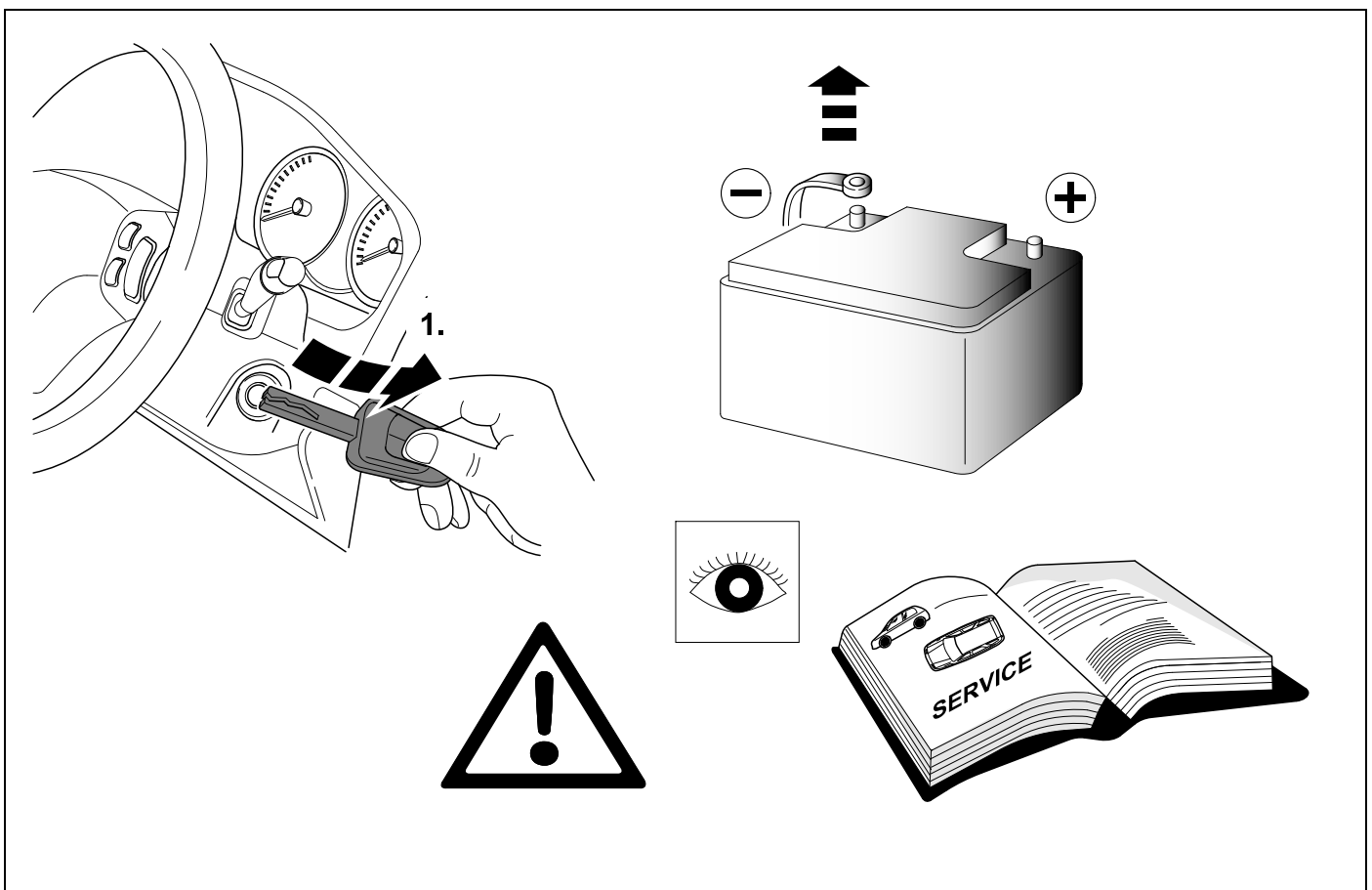

The diagram illustrates a key insertion step. On the left, a hand is shown inserting a key into the ignition cylinder, with a '1.' label and an arrow indicating the direction. To the right is a car battery with negative (-) and positive (+) terminals. Above the battery is an upward-pointing arrow with three horizontal bars. Below the battery is an eye icon. At the bottom center is a warning triangle with an exclamation mark. At the bottom right is an open service manual with the word 'SERVICE' on the cover.

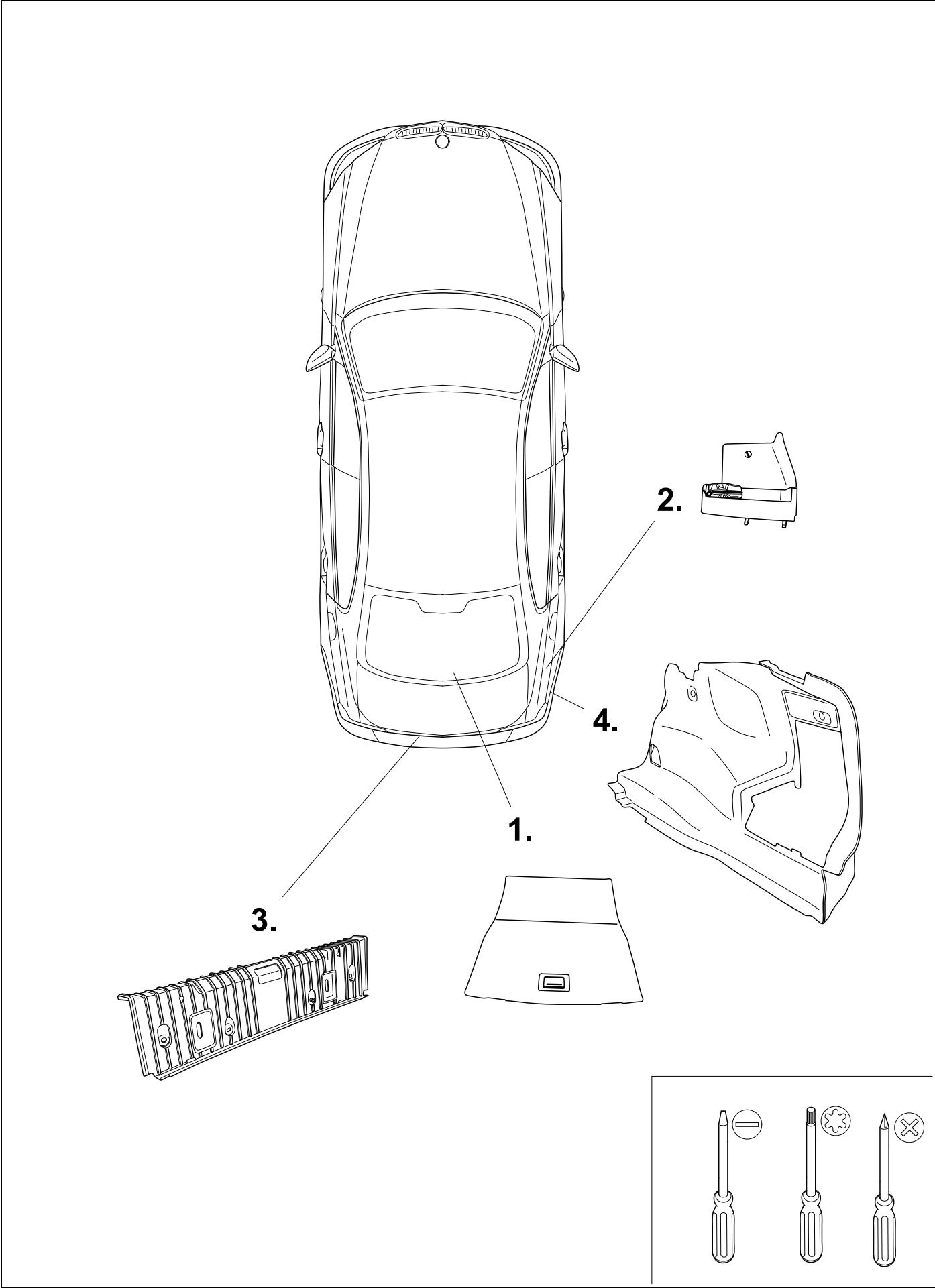
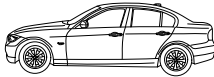

3

E90 / E92

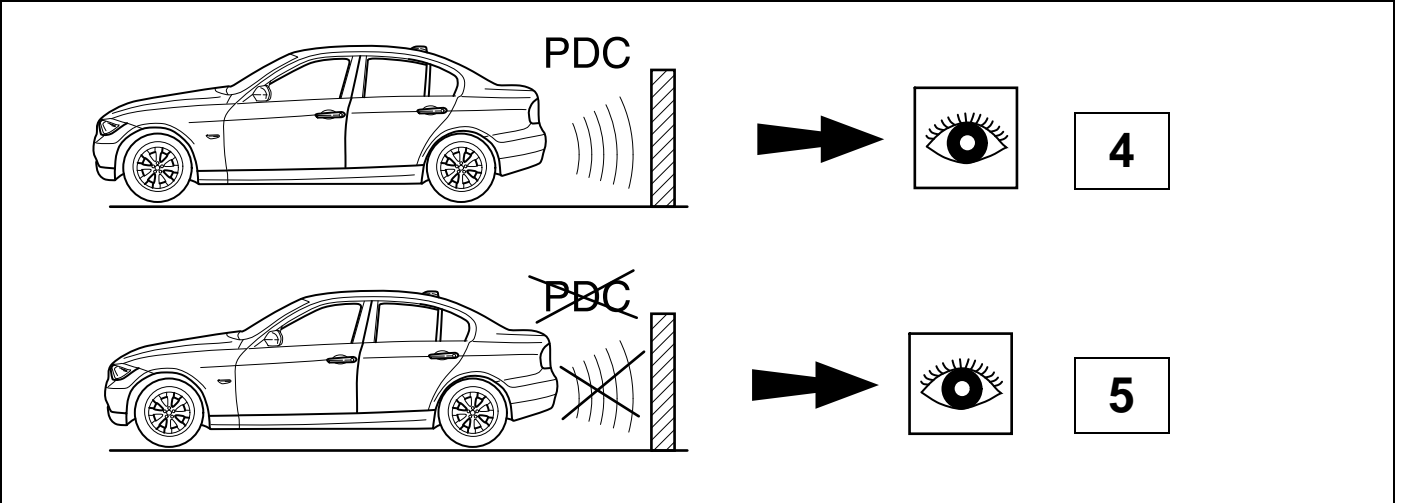
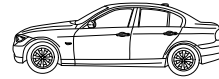

4

E90 / E92

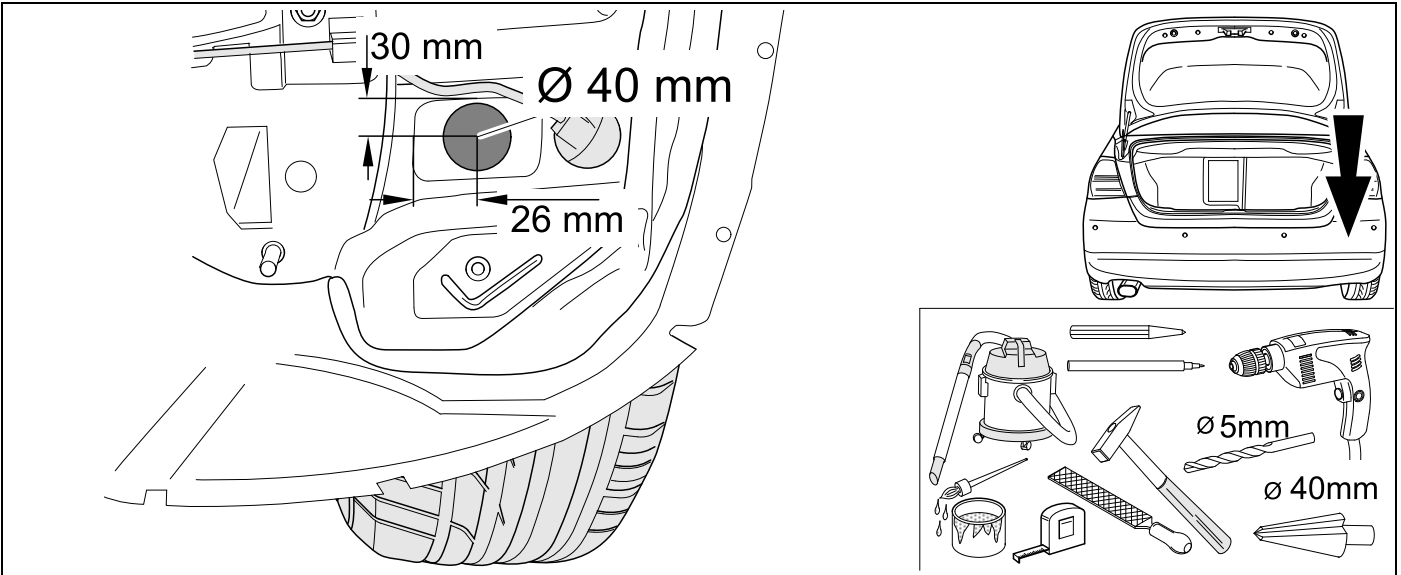
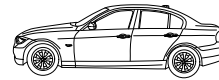

5

E90 / E92

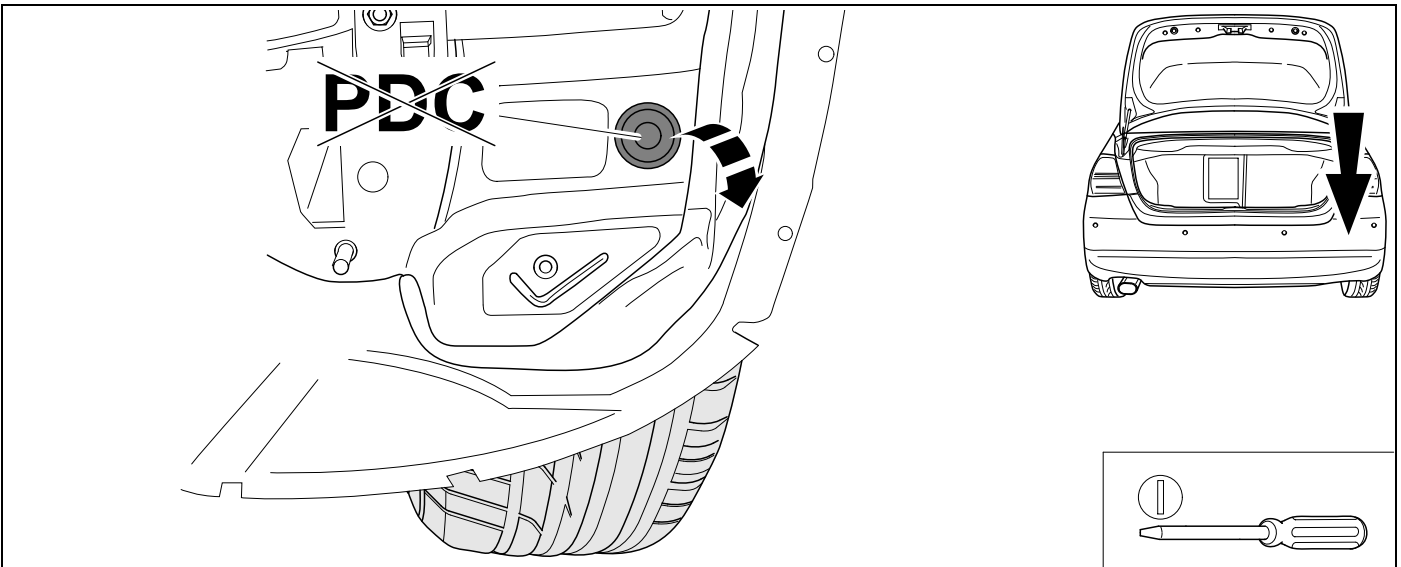
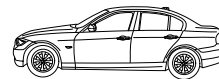

6

E90 / E92

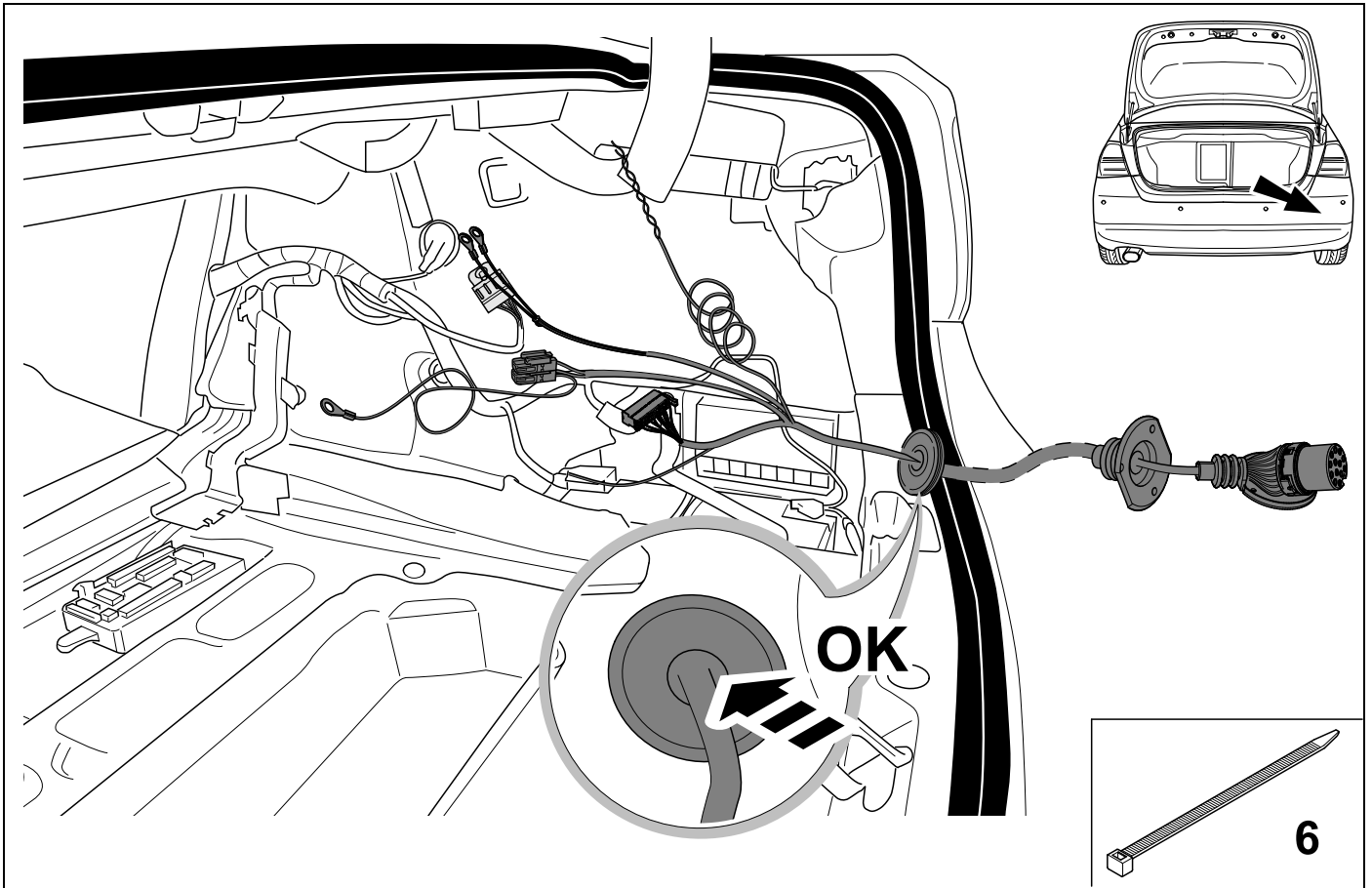
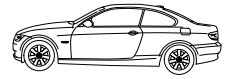
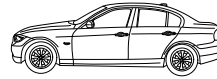

7

E90 / E92

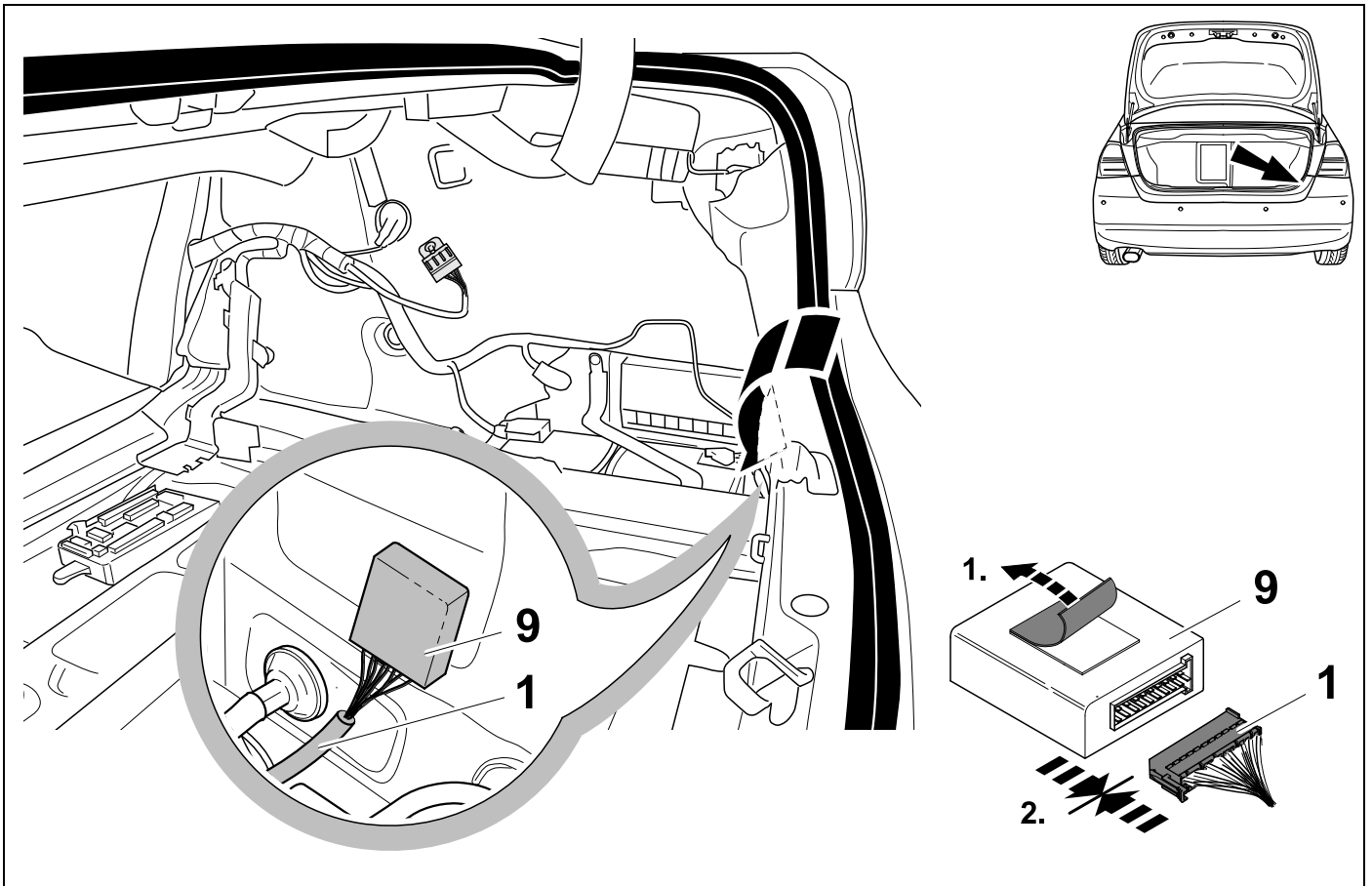
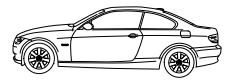
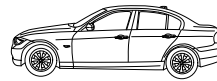

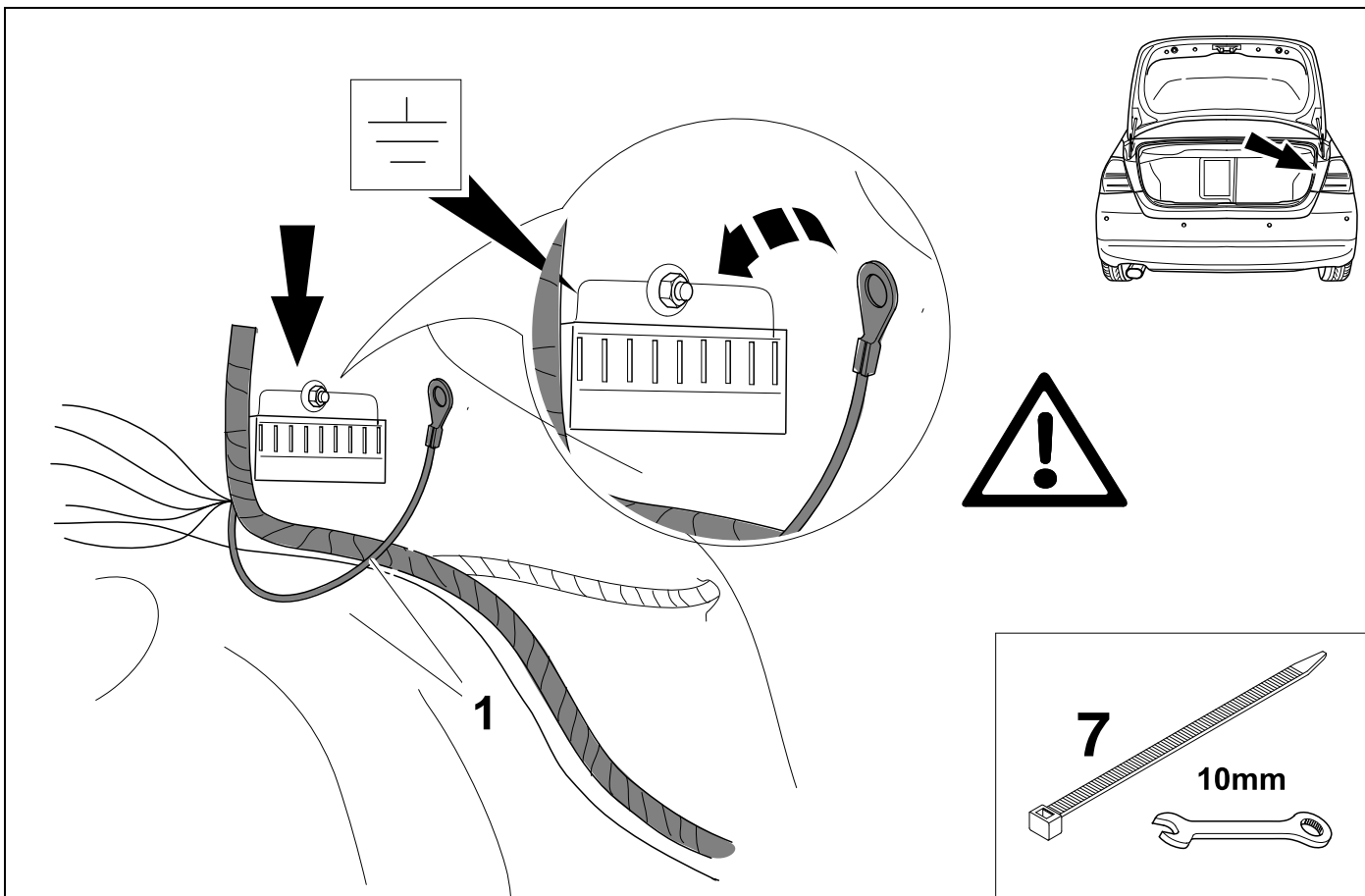
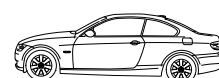
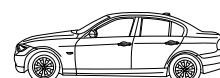
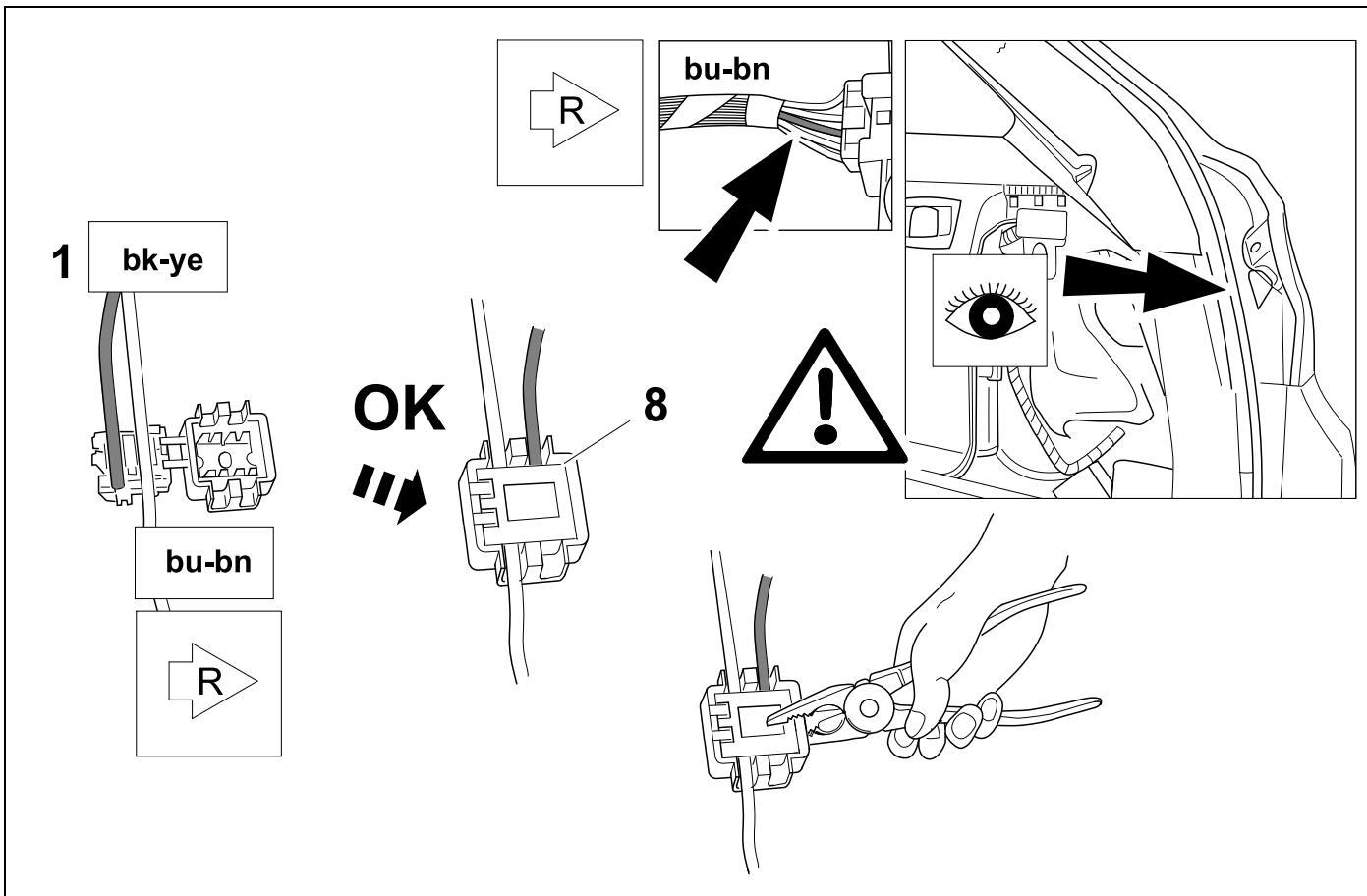
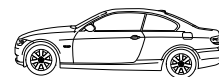
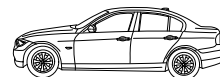

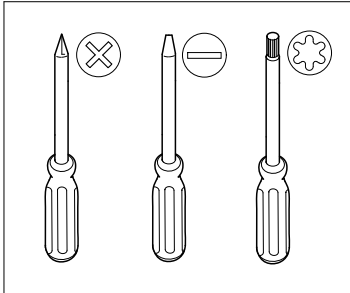
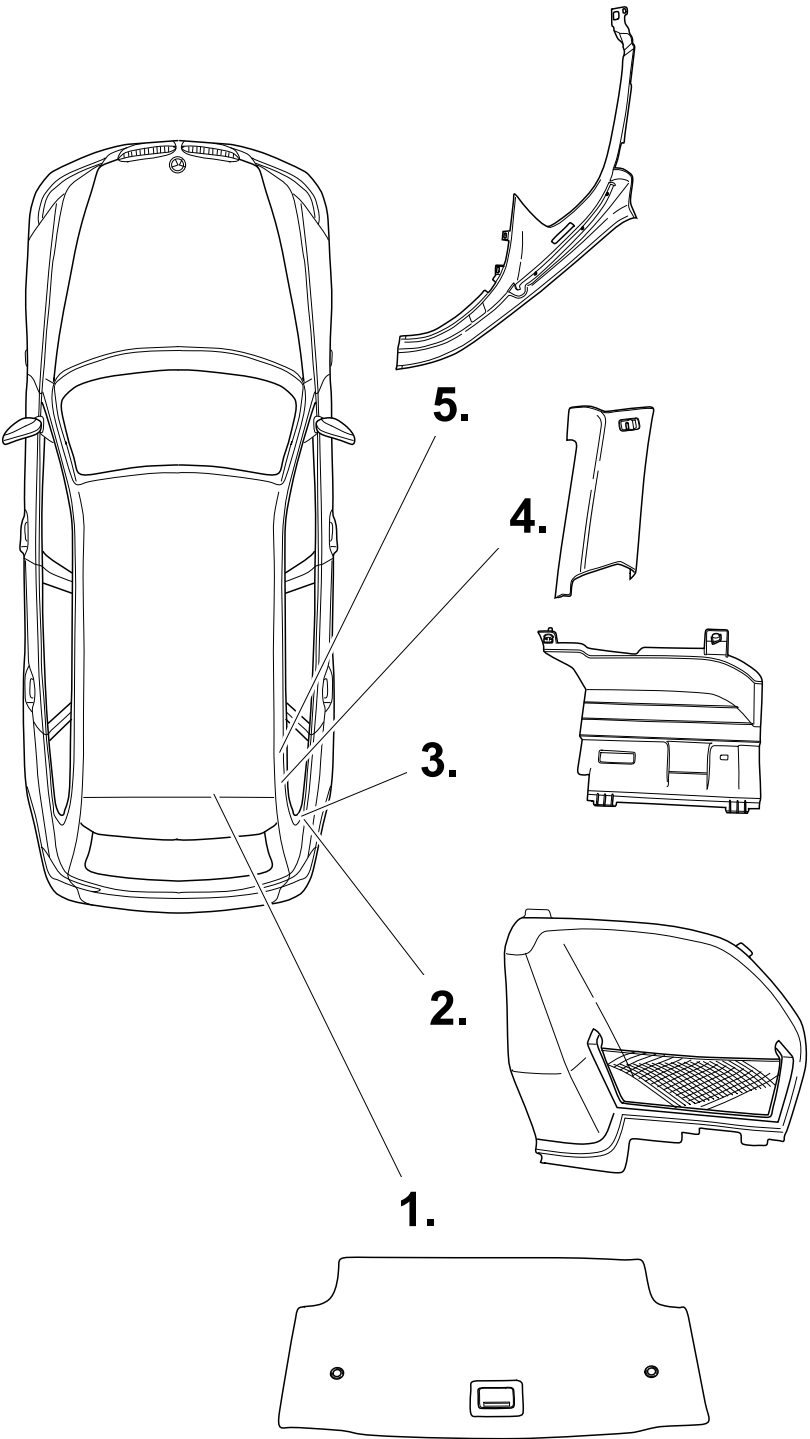
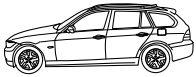

11

E91

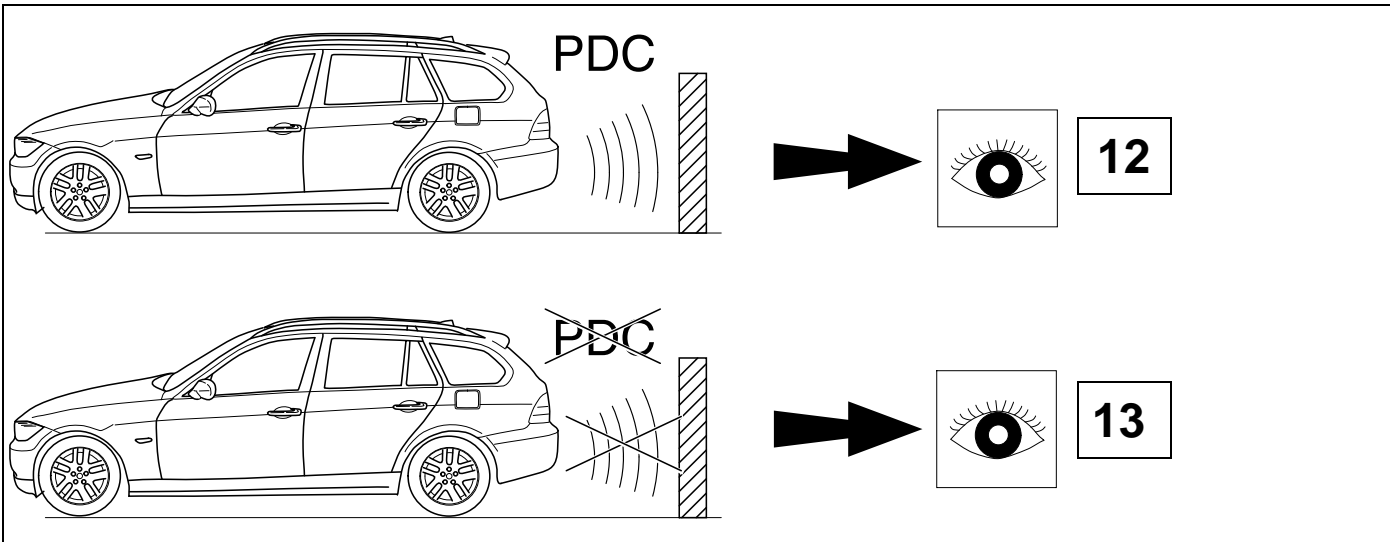
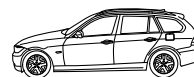

12

E91

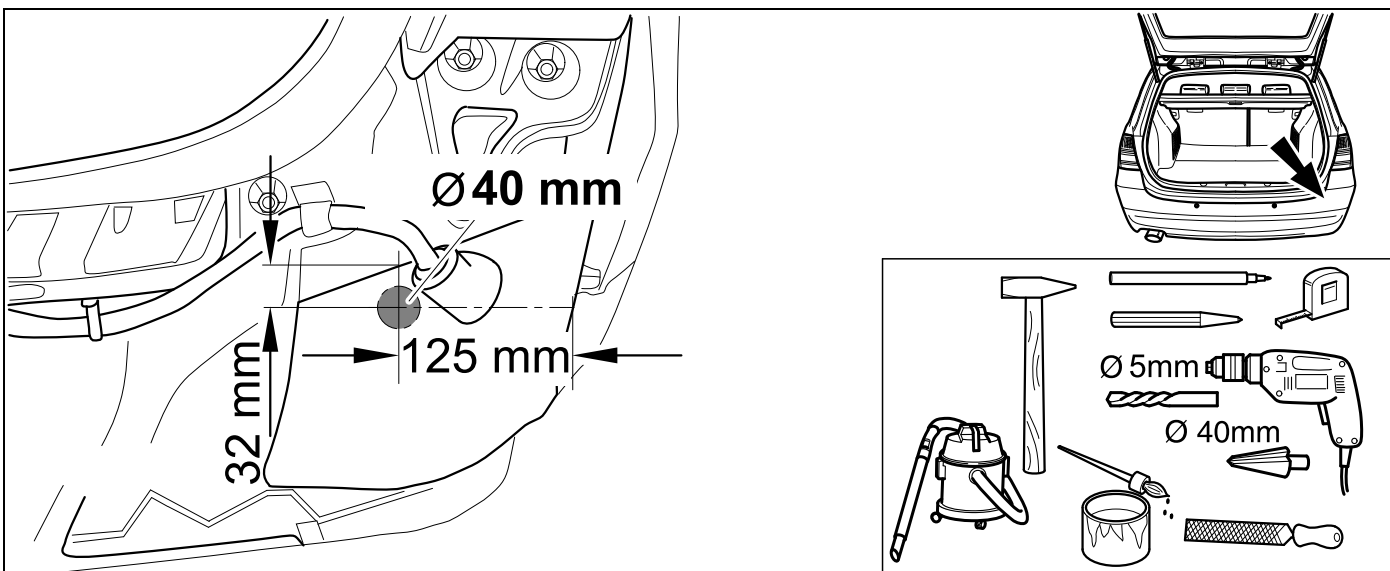
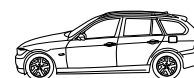

13

E91

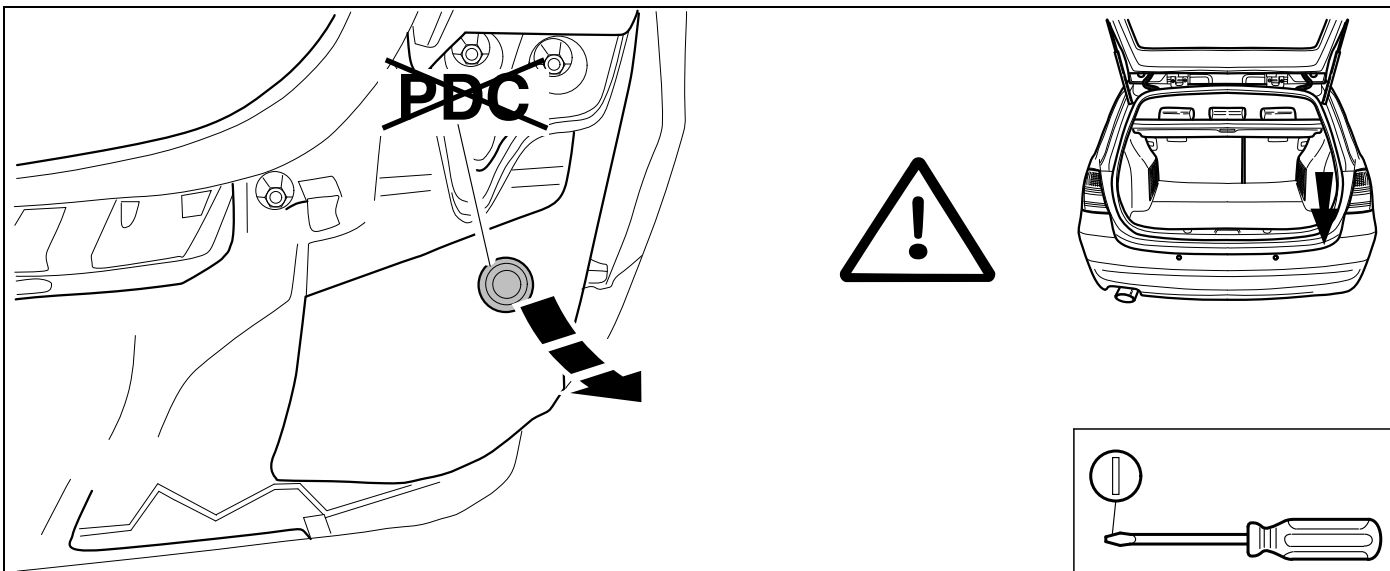
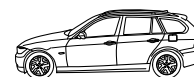

14

E91

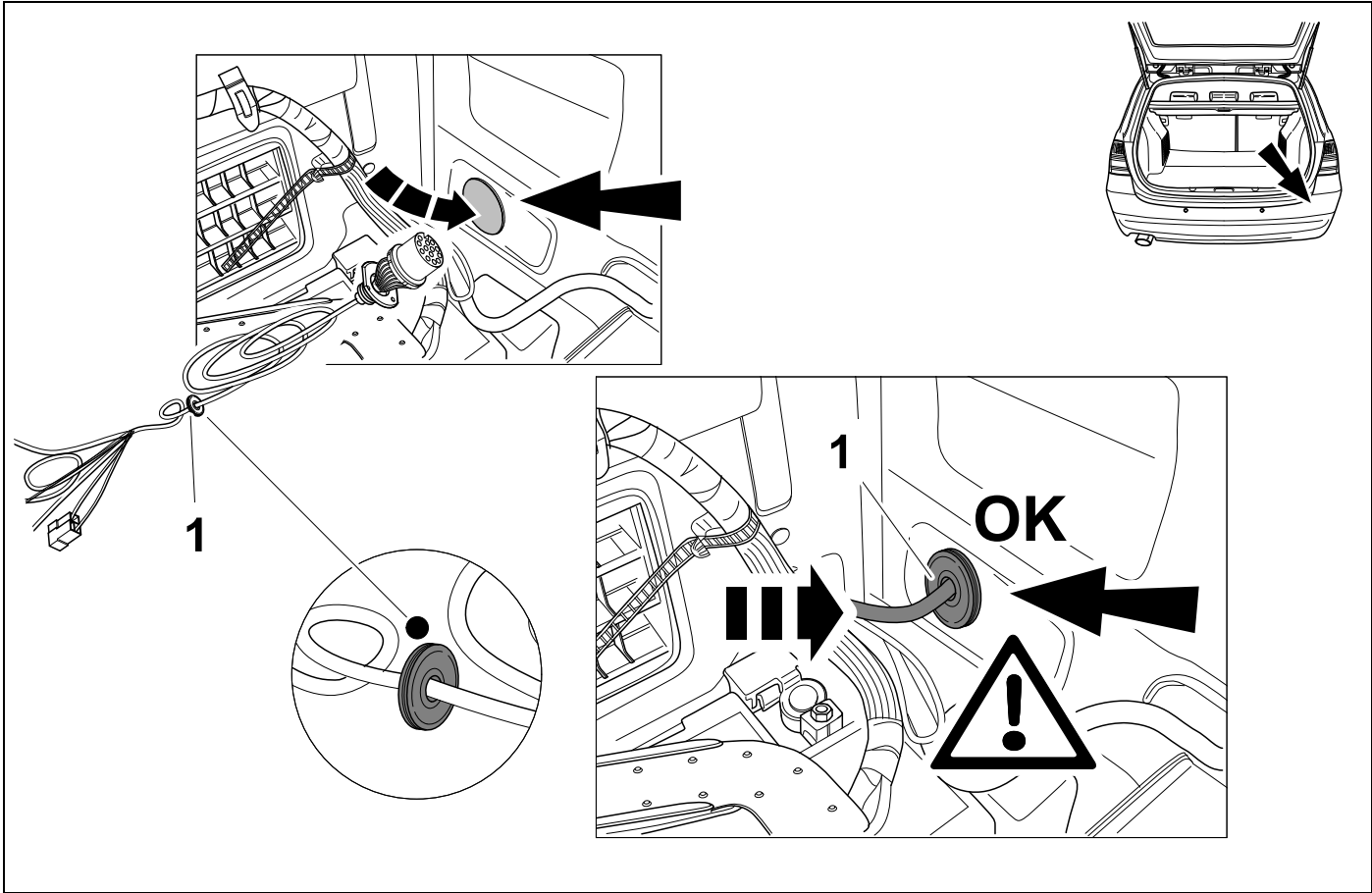

15

E91

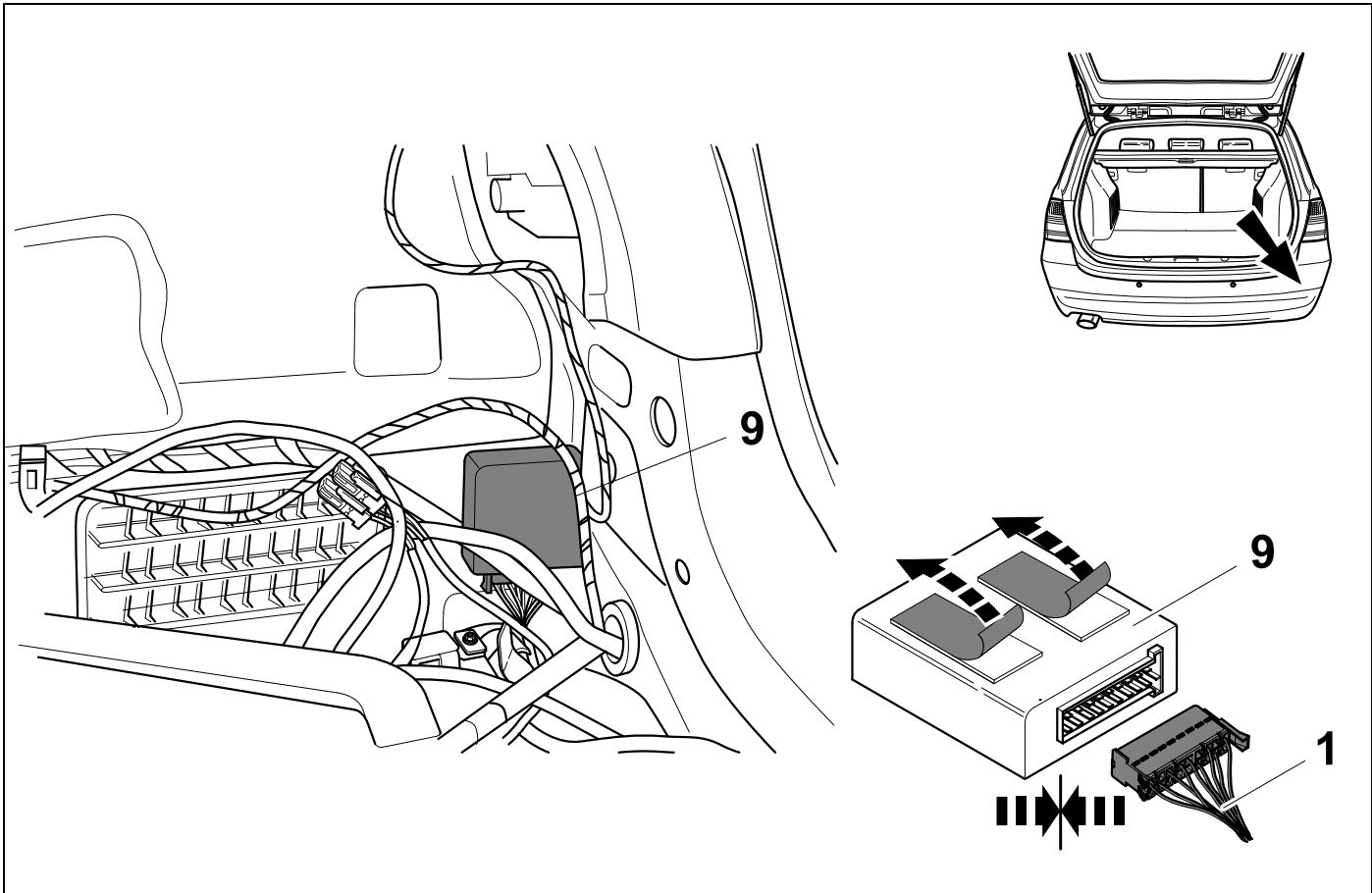

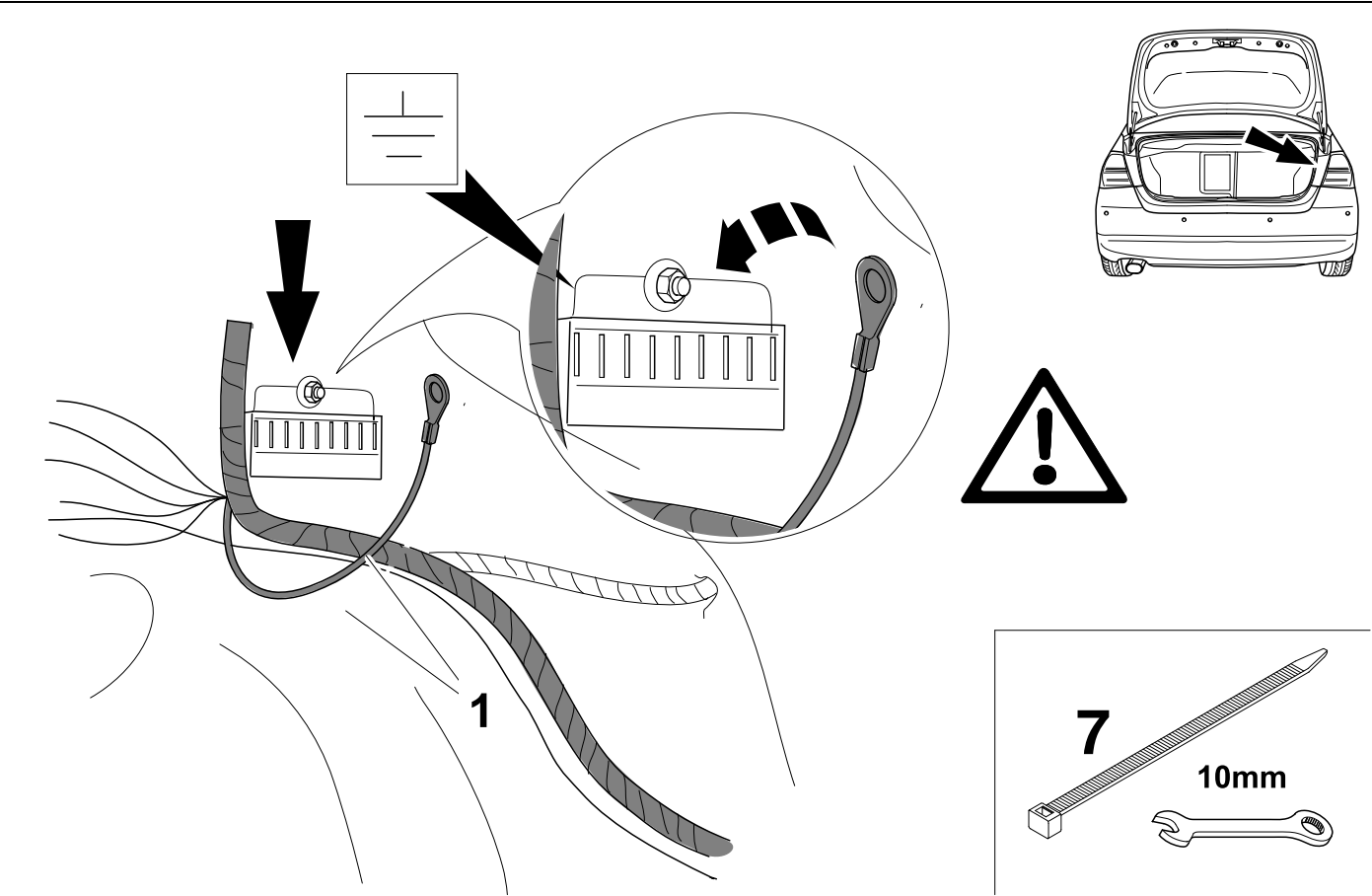
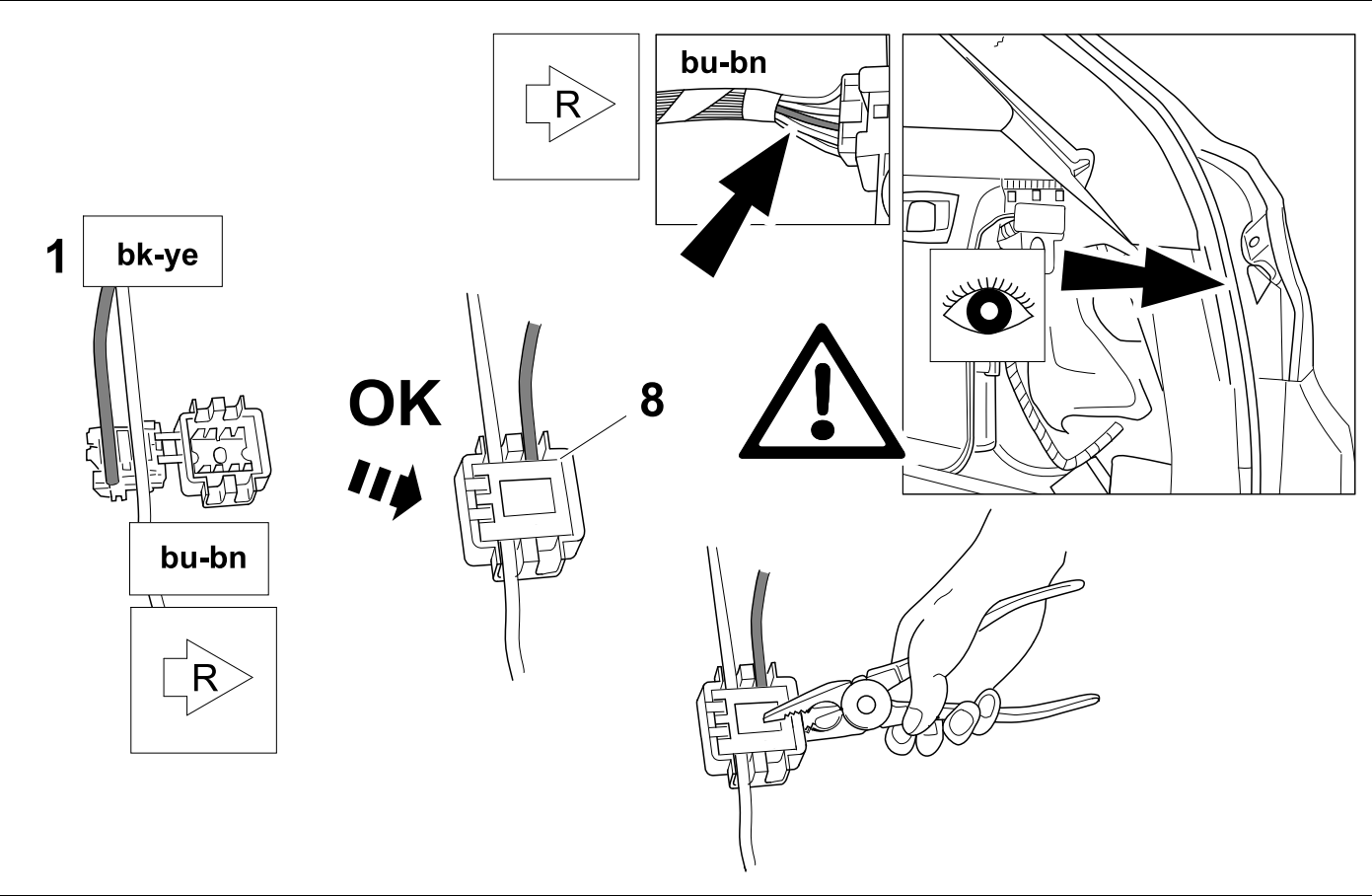
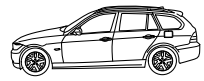

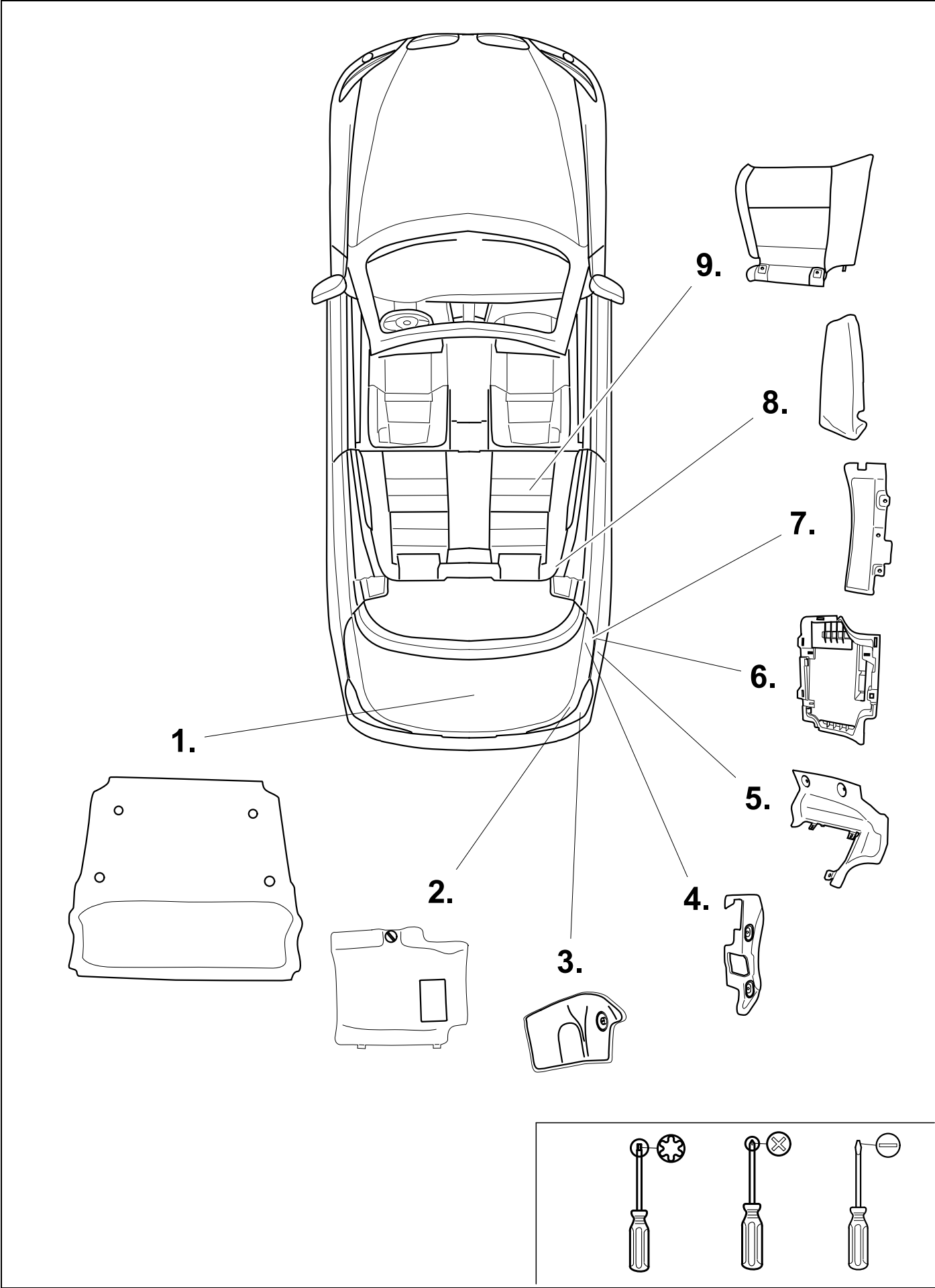
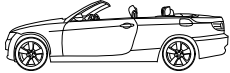

19

E93

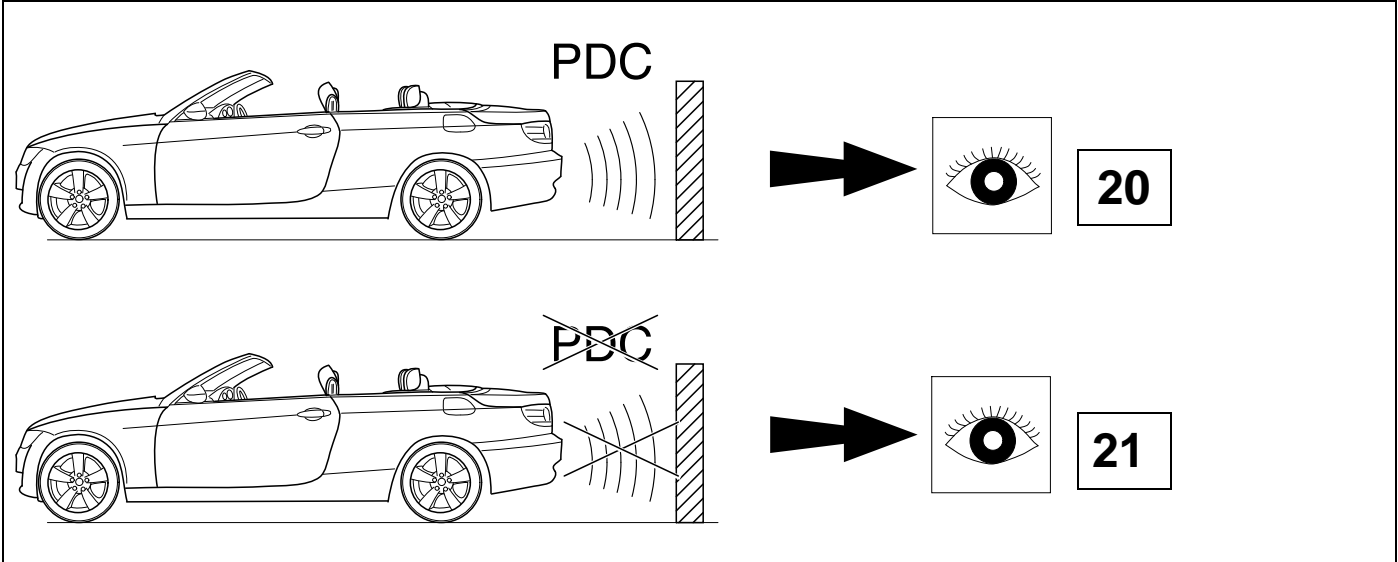
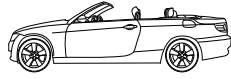

20

E93

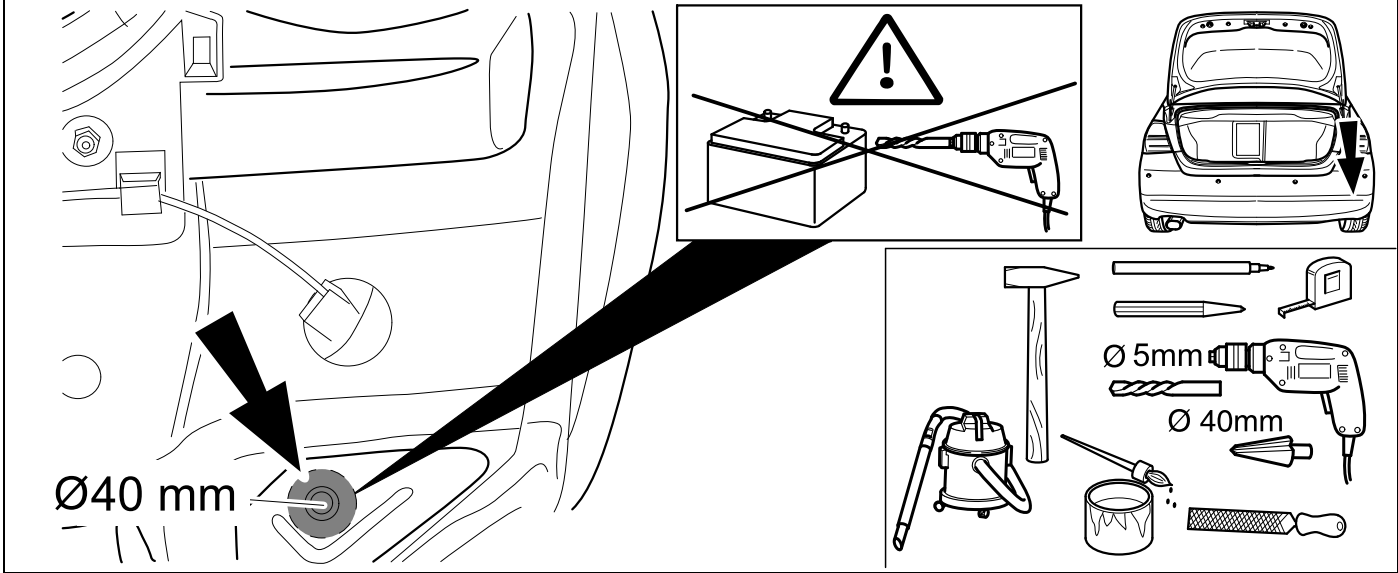
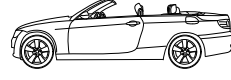

21

E93

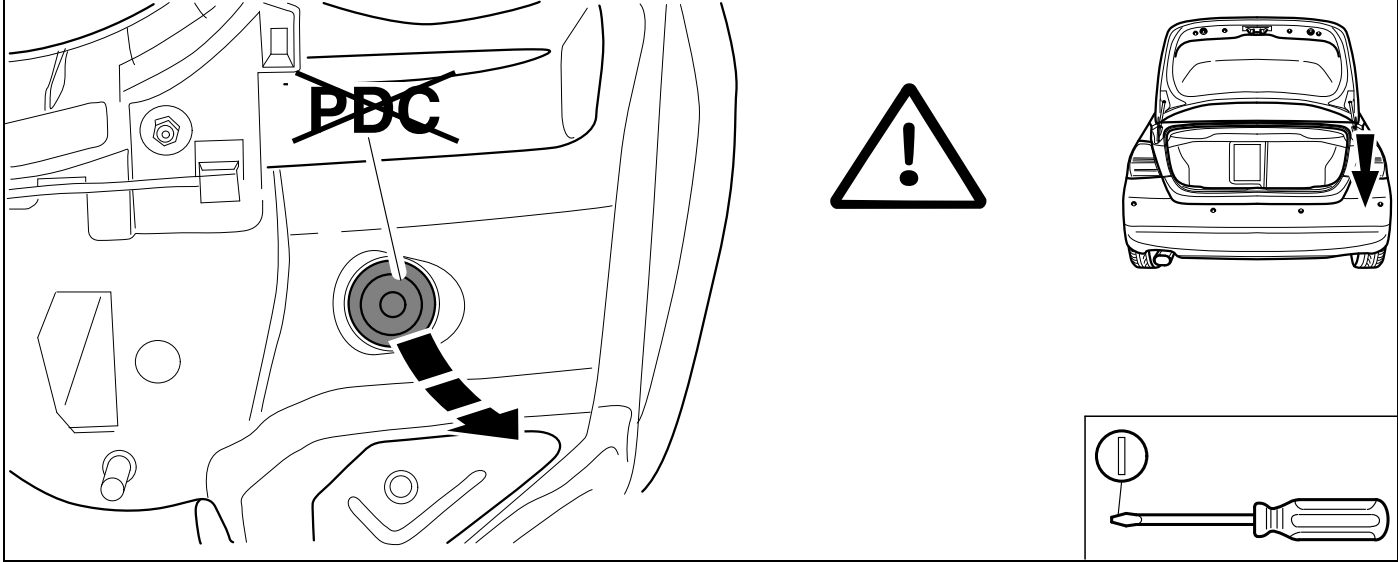
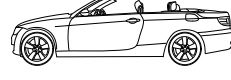

22

E93

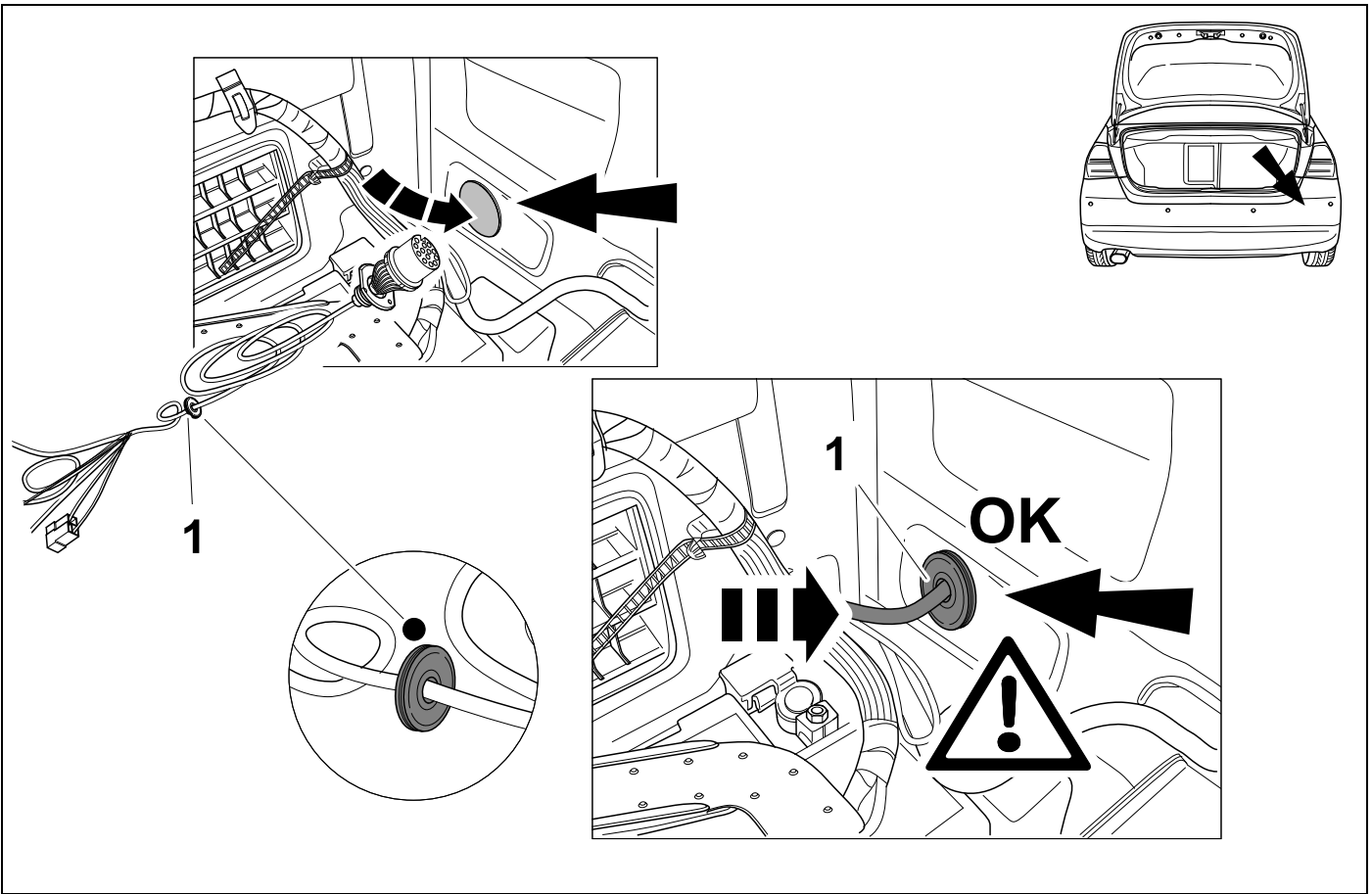
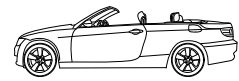

23

E93

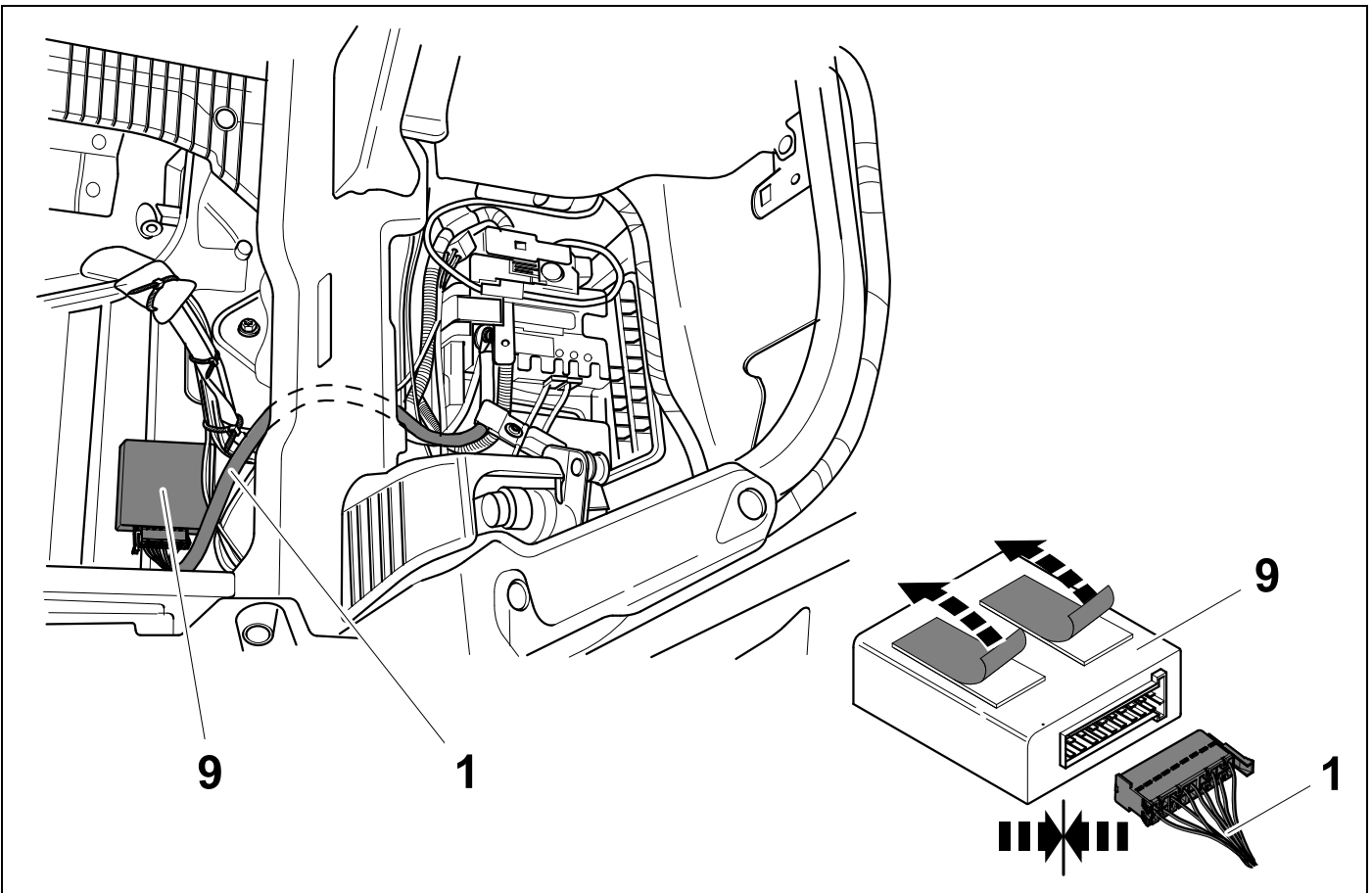
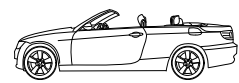

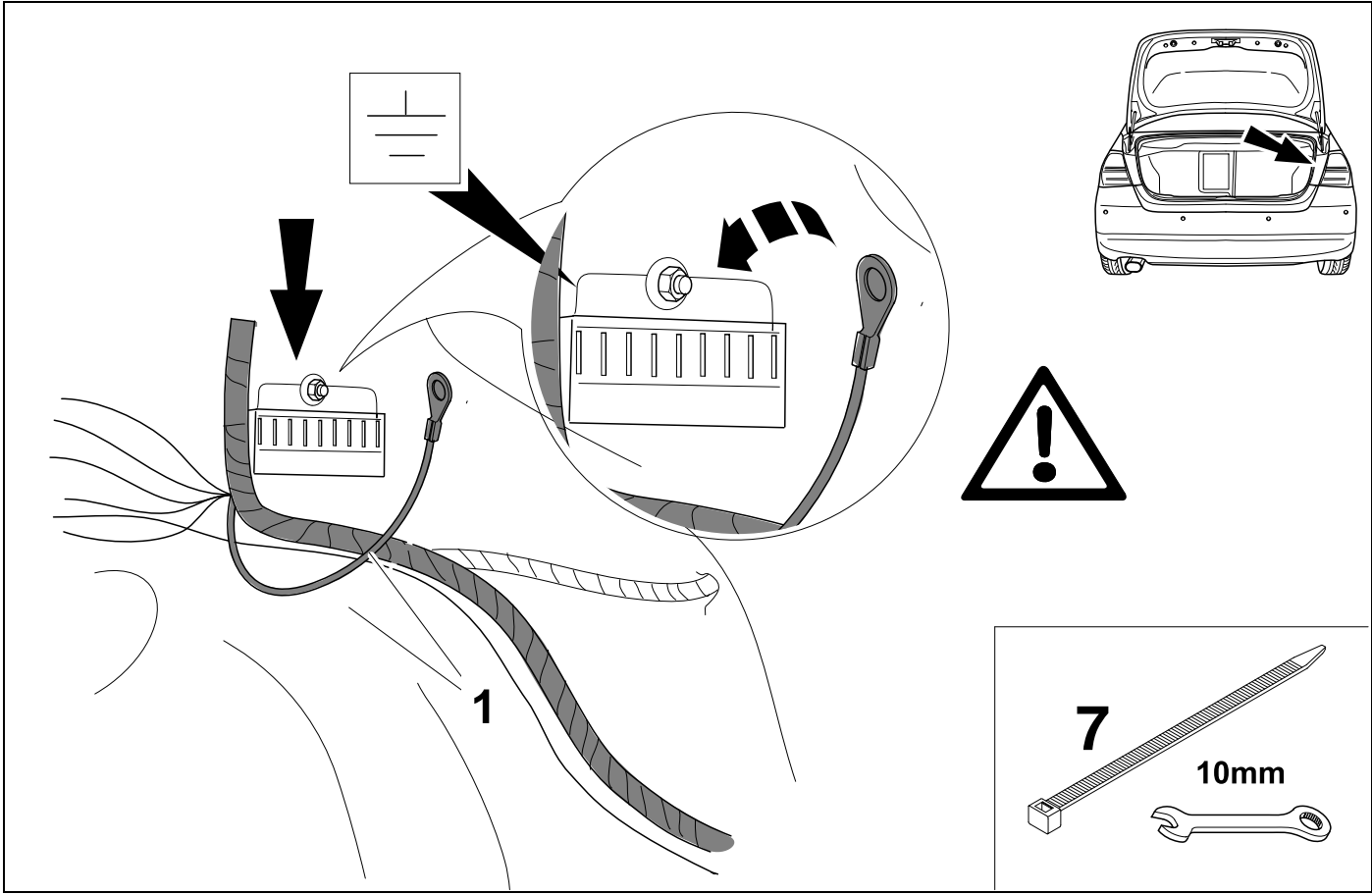
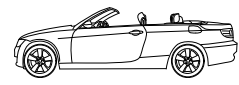
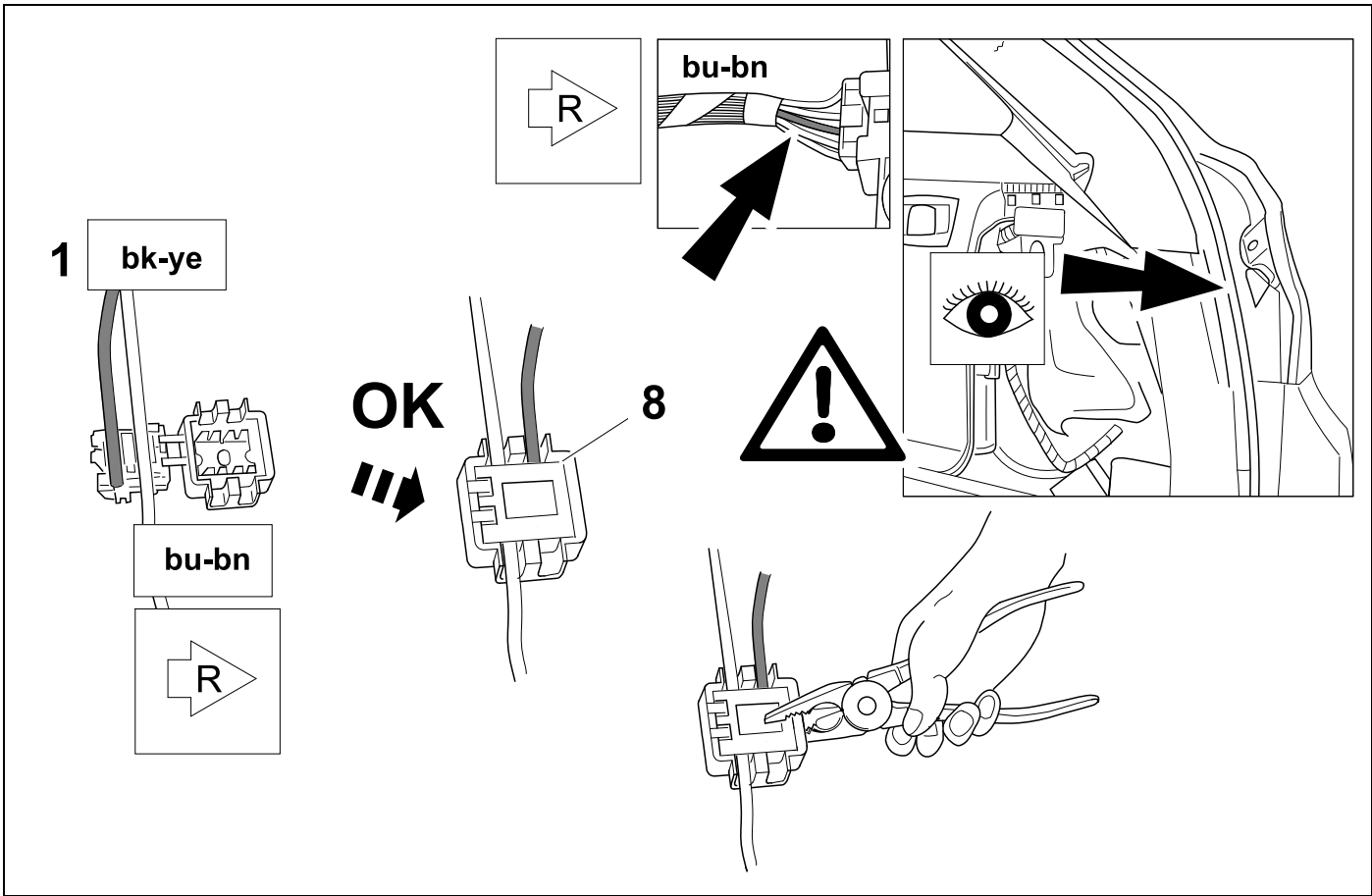
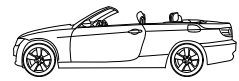

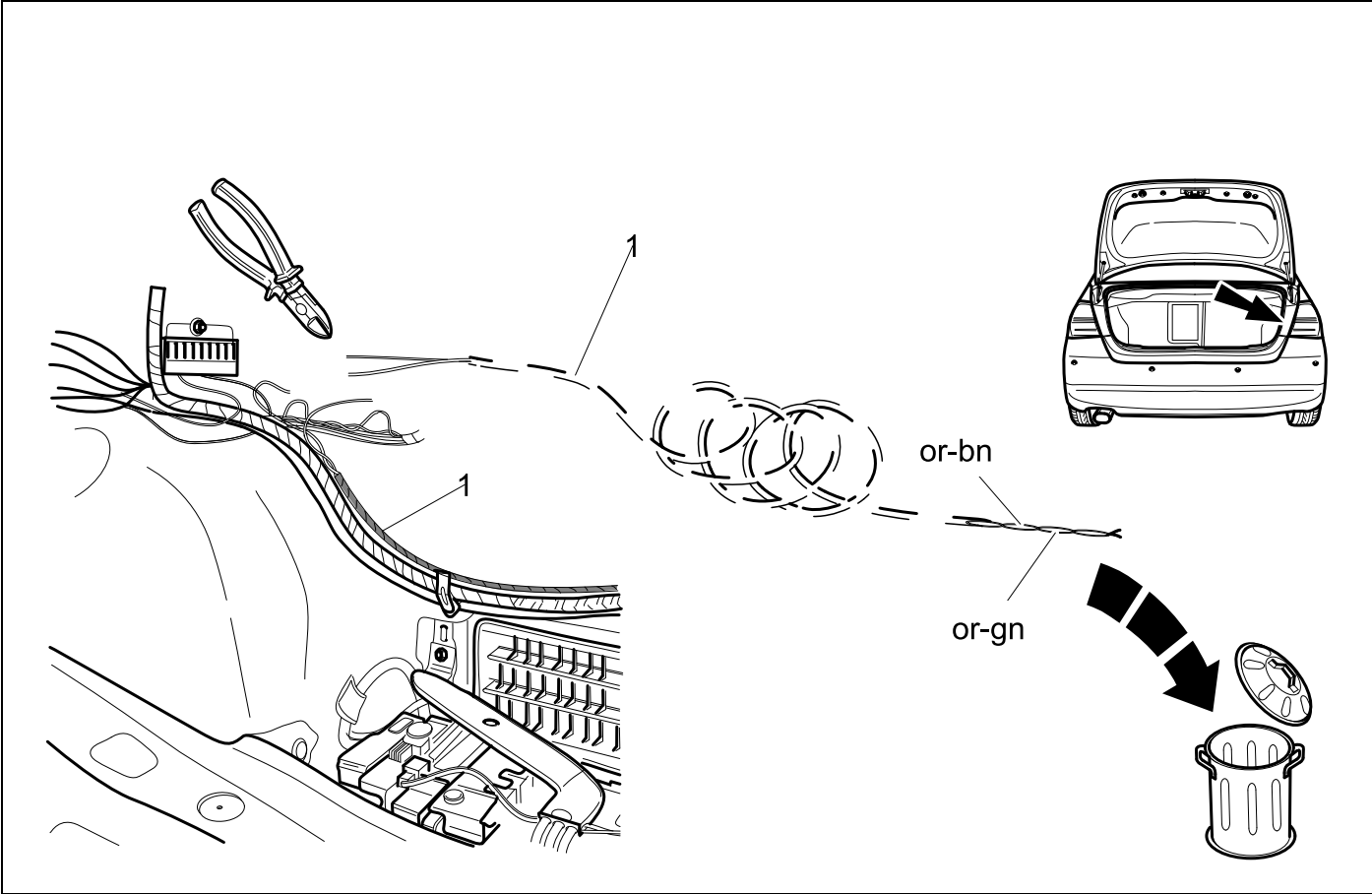
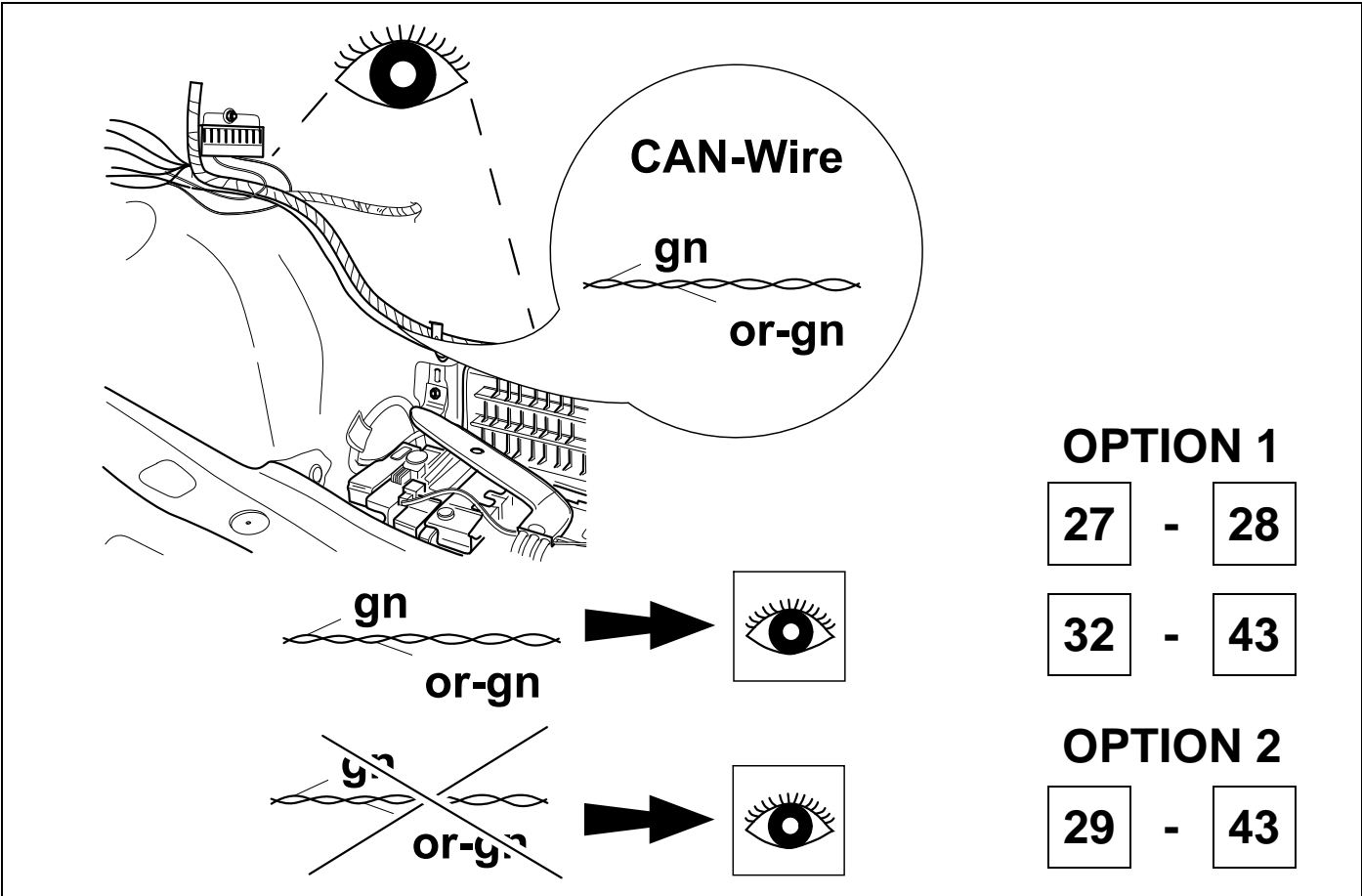

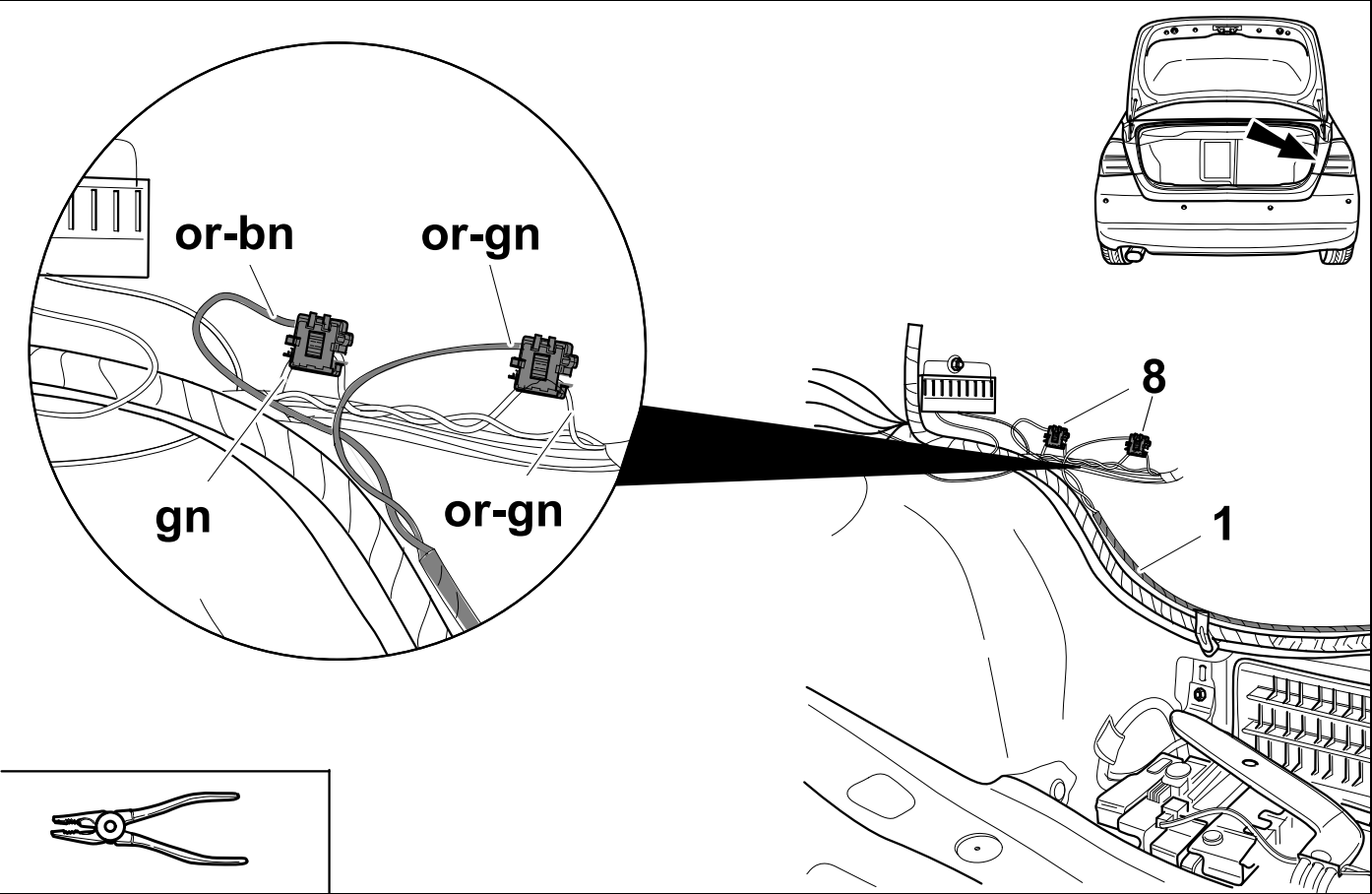



or-gn
or-bn

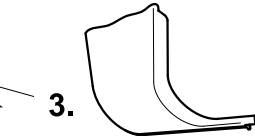
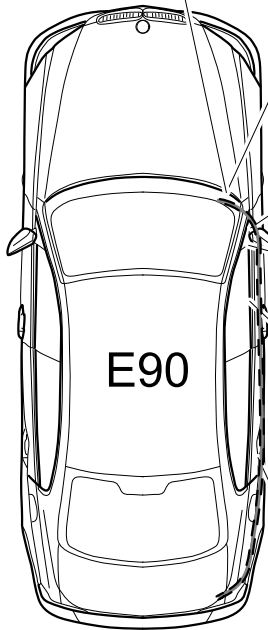
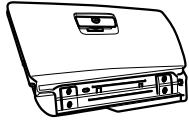
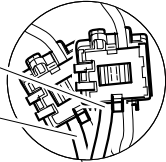

or-gn
or-bn

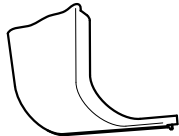
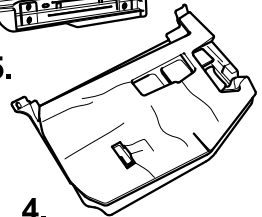
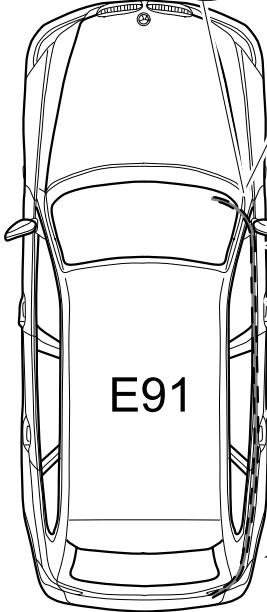
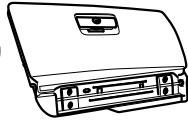
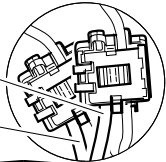

or-gn
or-bn

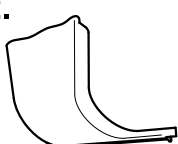
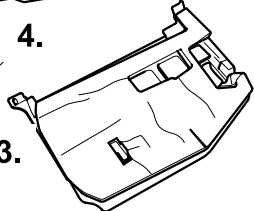
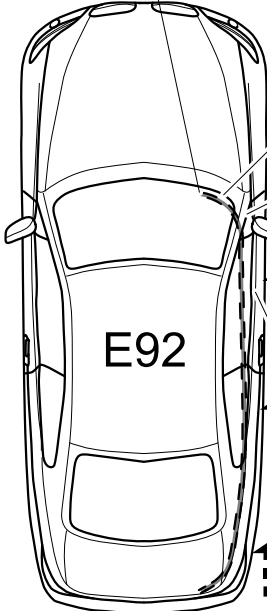
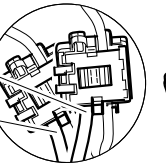

or-gn
or-bn

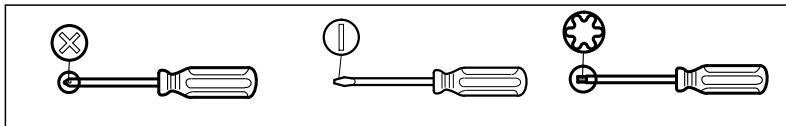
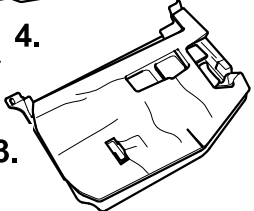
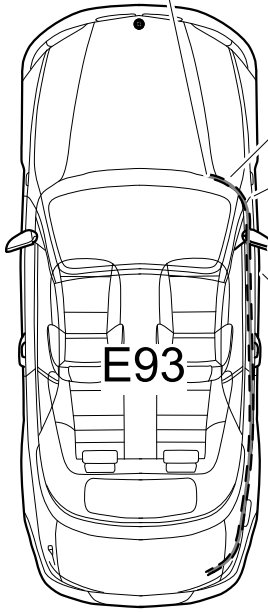
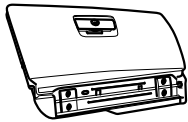
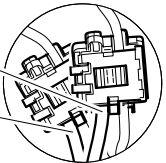

30

OPTION 2

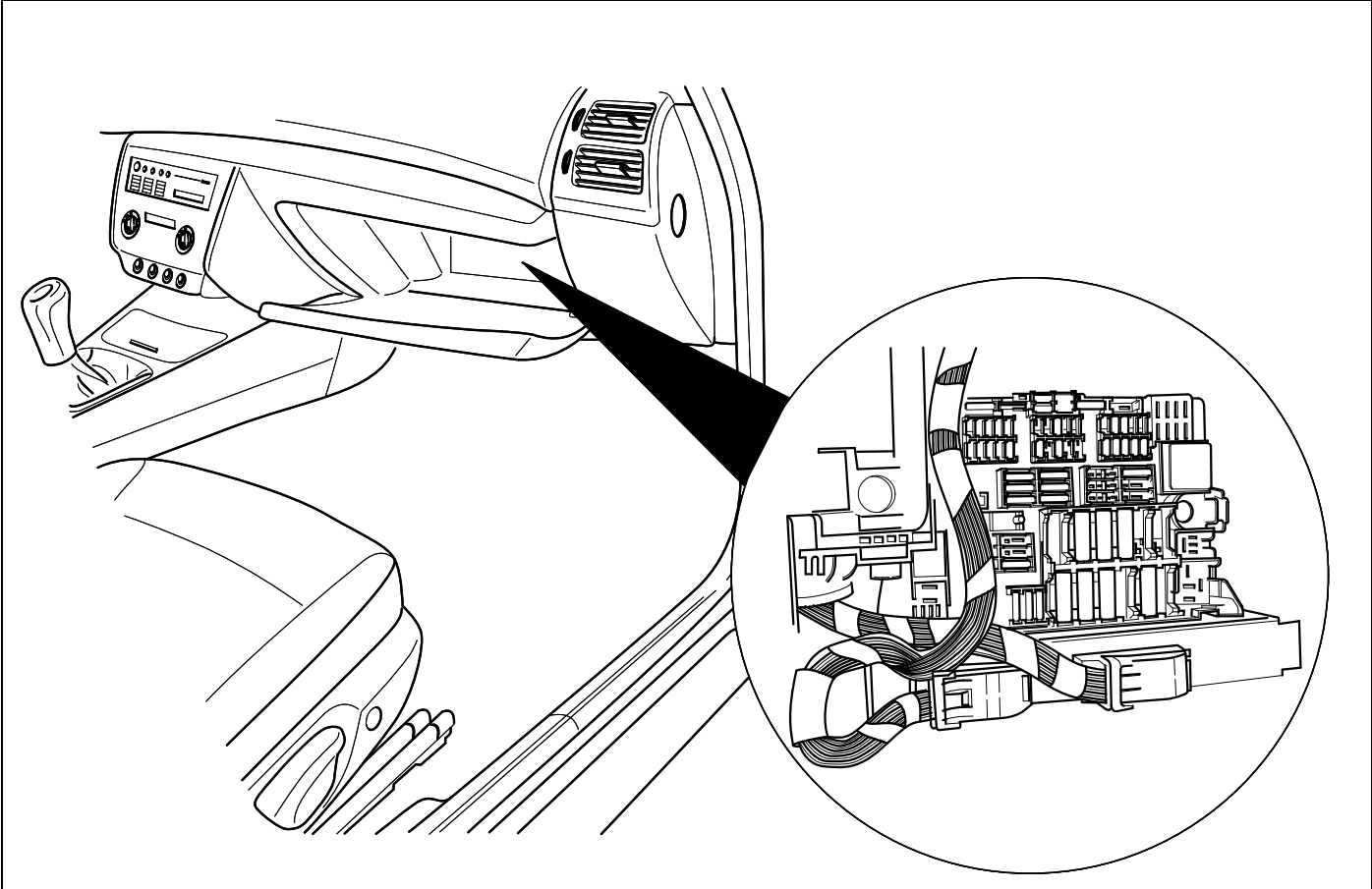

31

OPTION 2



36

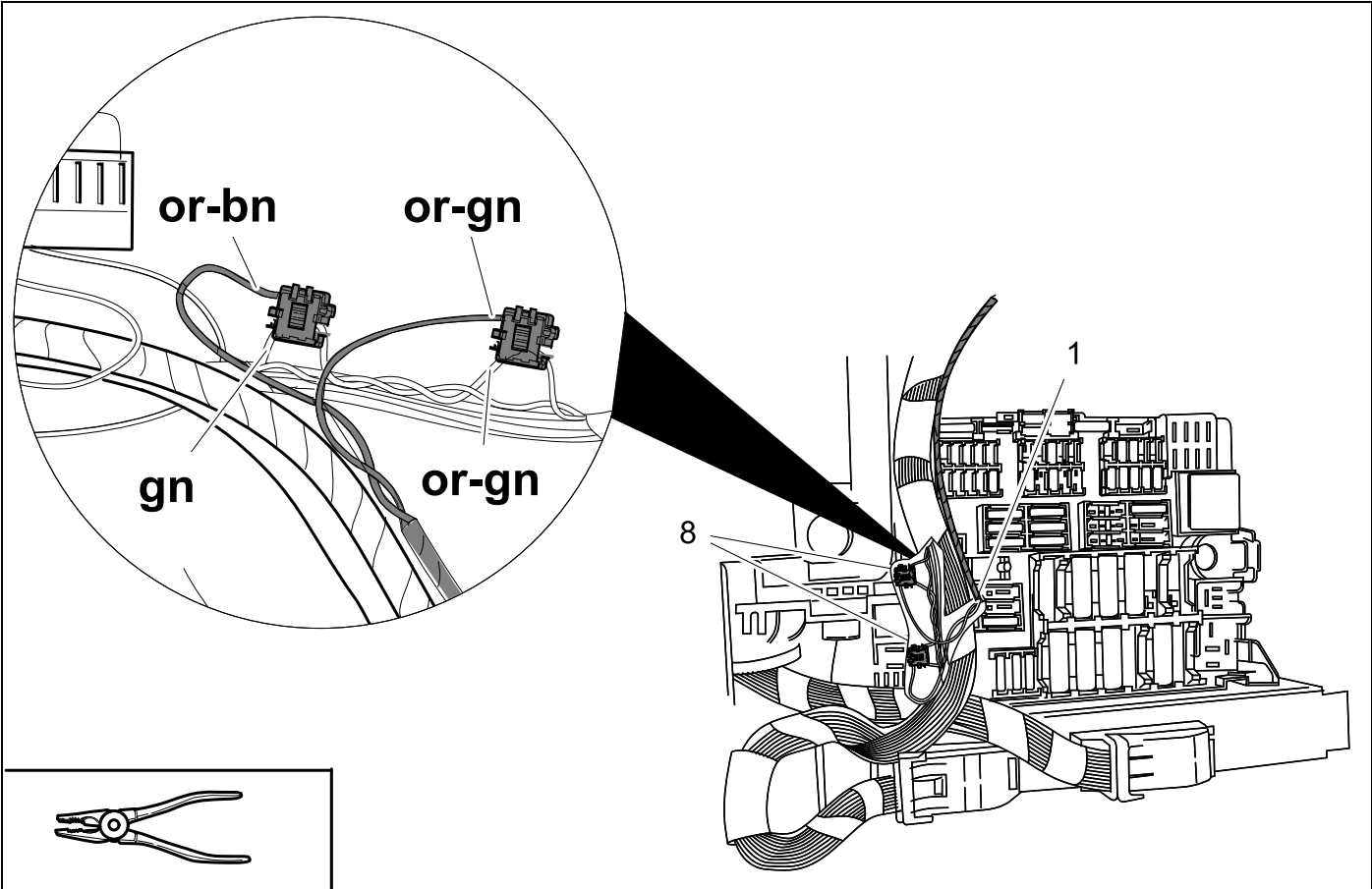

32

👁️ ⇒ 41

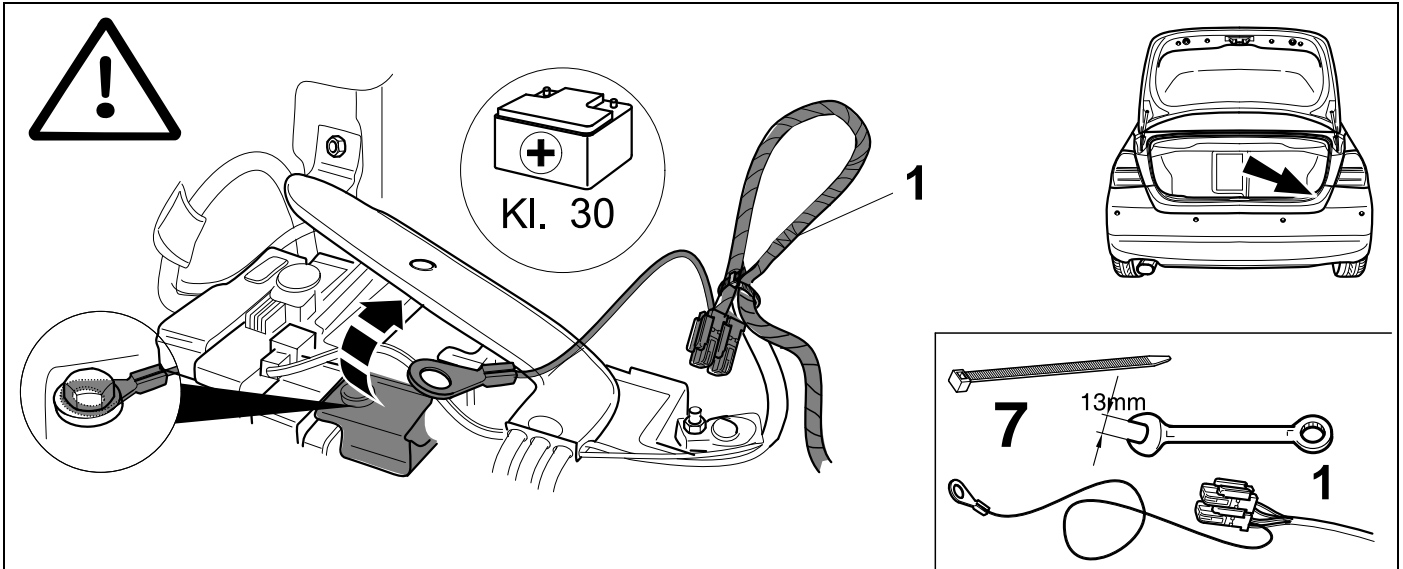

33

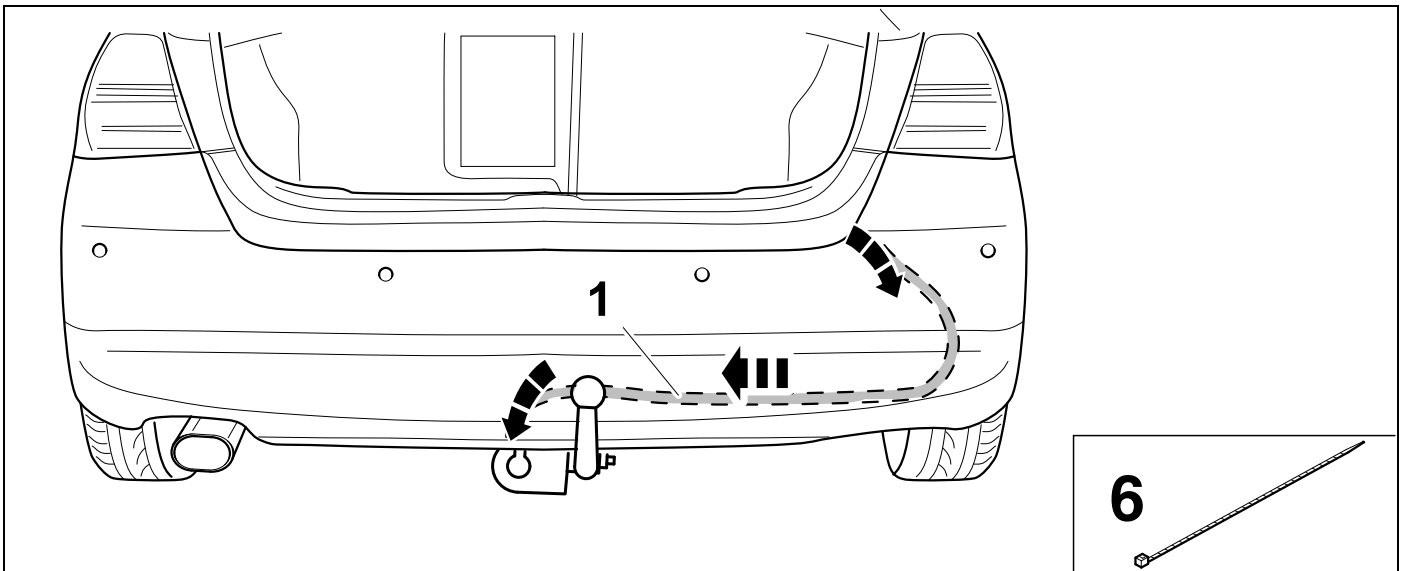

34

👁️ ⇒ 35

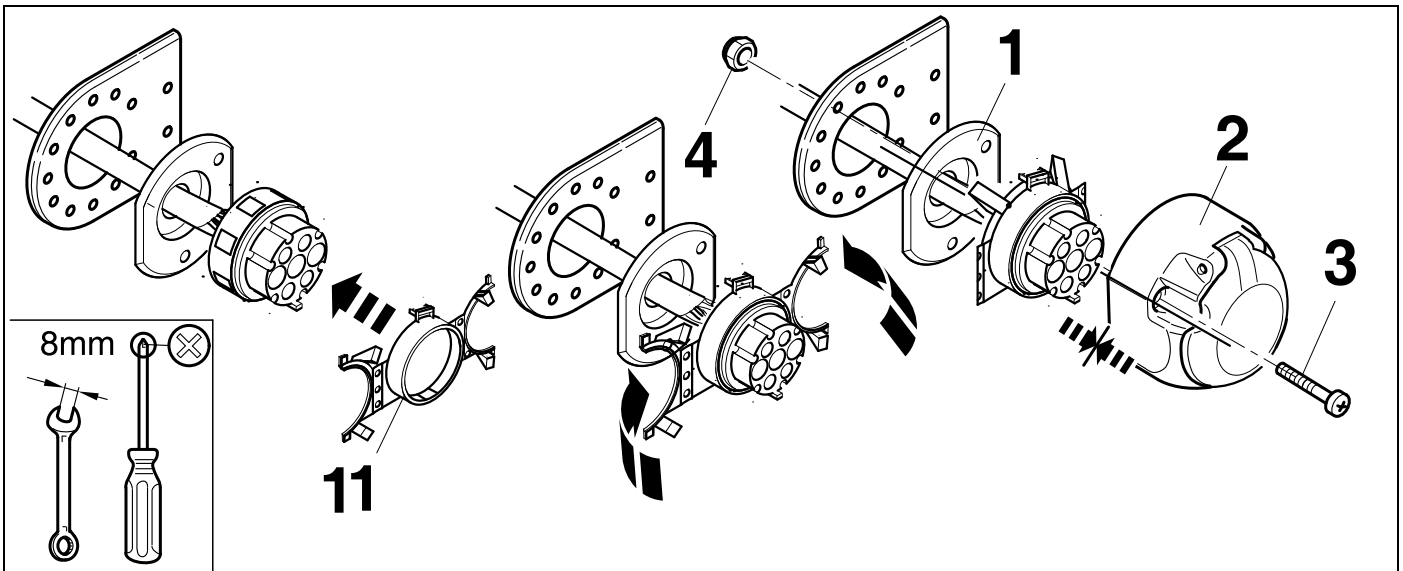



7 + 13 Pin			13 Pin		
1	bk/wh			bu/rd	8
2	gy			rd/bu	9
3	bn			ye	10
4	bk/gn			bn/gn	11
5	gy/rd		-/-	no	12
6	bk/rd			bn	13
7	gy/bk				

36	bk	wh	gy	gn	rd	bu	ye	bn	pu	or	no
(D)	schwarz	weiss	grau	grün	rot	blau	gelb	braun	violett	orange	nicht belegt
(GB)	black	white	grey	green	red	blue	yellow	brown	purple	orange	not occupied
(F)	noir	blanc	gris	vert	rouge	bleu	jaune	brun	violet	orange	inutilisé
(NL)	zwart	wit	grijs	groen	rood	blauw	geel	bruin	violet	oranje	niet aangesloten
(DK)	sort	hvid	grå	grøn	rød	blå	gul	brun	violet	orange	ikke anvendt
(N)	svart	hvit	grå	grønn	rød	blå	gul	brun	fiolett	oransje	ikke i bruk
(S)	svart	vit	grå	grön	röd	blå	gul	brun	violett	orange	ej använd
(FIN)	musta	valkoinen	harmaa	vihreä	punainen	sininen	keltainen	ruskea	violetti	oranssi	ei varattu
(I)	nero	bianco	grigio	verde	rosso	blu	giallo	marrone	viola	arancione	libero
(E)	negro	blanco	gris	verde	rojo	azul	amarillo	marrón	violeta	anaranja-do	no ocupado
(P)	preto	branco	cinzento	verde	vermelho	azul	amarelo	castanho	violeta	laranja	não ocupado
(GR)	μαύρος	λευκός	Γκρι	πράσινος	κόκκινος	μπλε	κίτρινος	καφέ	Μωβ	πορτοκαλί	δεν είναι κοτ ειλημμένος
(PL)	czarny	biały	szaro	zielony	czerwony	niebiesko	żółty	brazowy	fioletowy	pomarańczowy	wolny
(CZ)	černý	bílý	šedý	zelený	červený	modrý	žlutý	hnědý	fialový	oranžový	neobsazen
(TR)	siyah	beyaz	gri	yeşil	kırmızı	mavi	sarı	kahverengi	mor	portakal rengi	boş
(H)	fekete	fehér	szürke	zöld	piros	kék	sárga	barna	ibolyakék	narancssárga	nem foglalt
(HR)	crno	bijelo	sivo	zeleno	crveno	plavo	zuto	smeđe	ljubičasto	narandasto	nije zauzeto
(BUL)	черен	бял	сив	зелен	червен	син	жълт	кафяв	виолетов	оранжев	свободно
(RO)	negru	alb	gri	verde	roșu	albastru	galben	maro	violet	portocaliu	liber
(RU)	черный	белый	серый	зеленый	красный	голубой	жёлтый	коричневый	пурпурный	оранжевый	свободно
(LT)	juoda	balta	pilka	žalia	raudona	mėlyna	geltona	ruda	purpurinė	oranžinė	laisva
(LV)	melna	balta	pelēka	zaļa	sarkana	zila	dzeltena	brūna	purpur-sarkana	oranža	brīvs
(EST)	must	valge	hall	roheline	punane	sinine	kollane	pruun	purpur-punane	oraanž	vaba
(SLO)	črna	bela	siva	zelena	rdeča	modra	rumena	smeđ	vijoličast	oranžen	ni zasedeno
(SK)	čierny	biely	šedý	zelený	červený	modrý	žltý	hnědý	fialový	pomaraňový	neobsadený

37

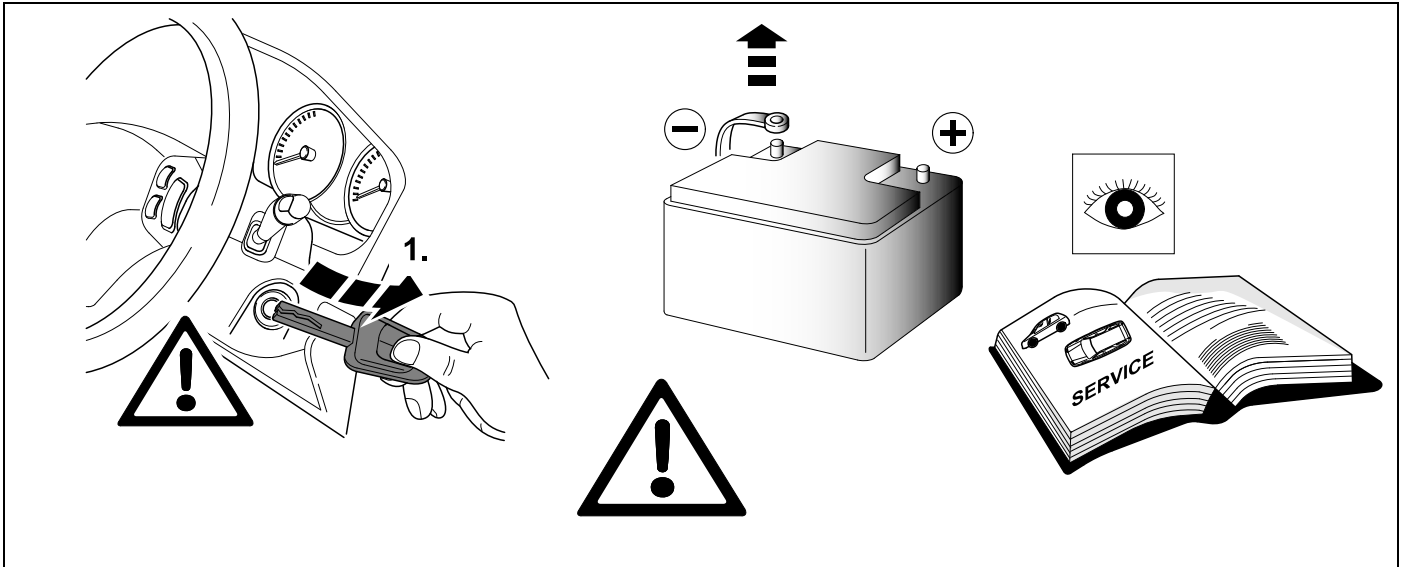

38 CHECK

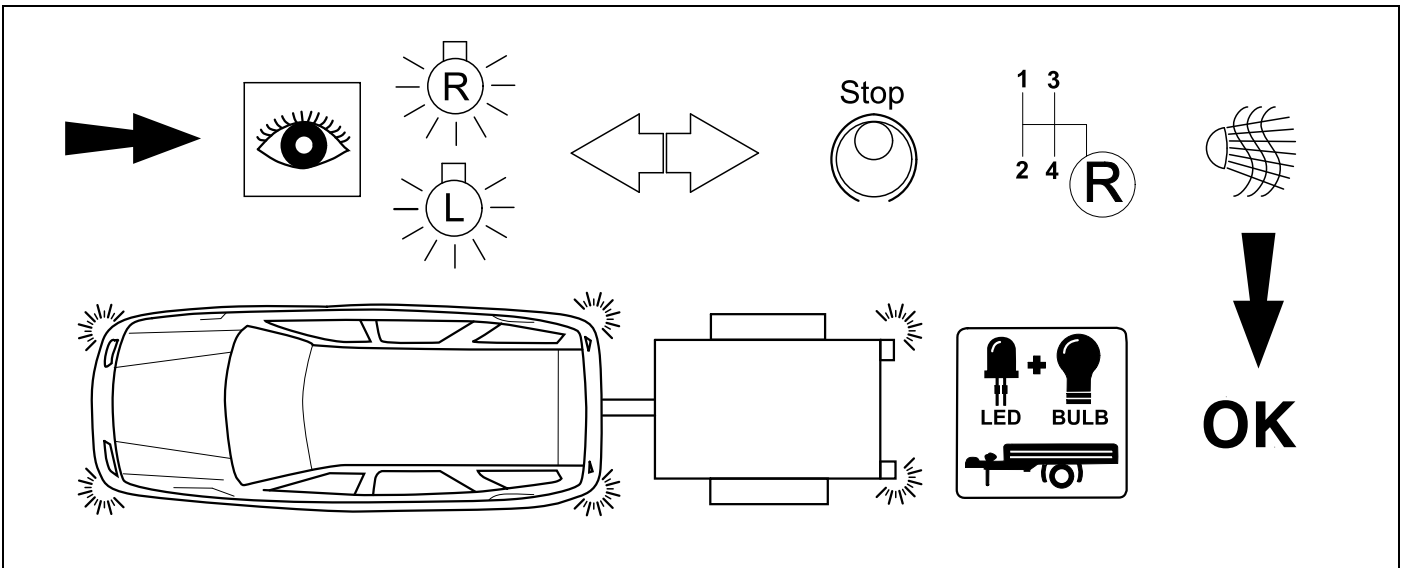

39 CHECK

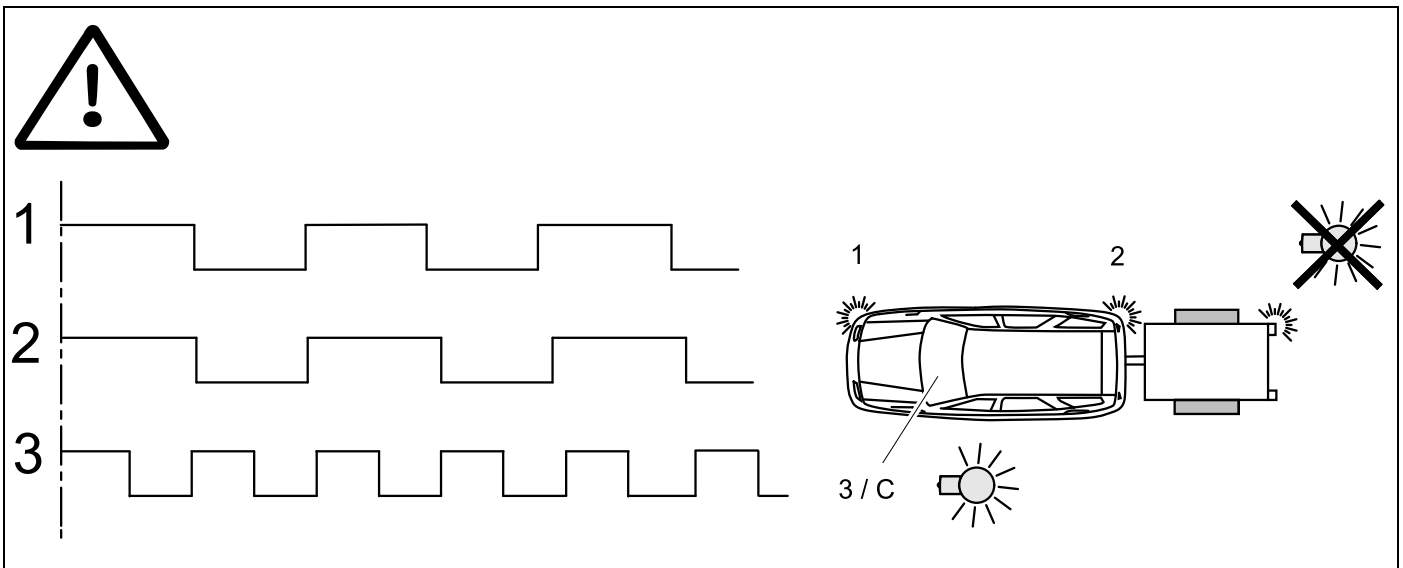



ISTA/P Do not initialize Trailer Modul

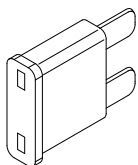
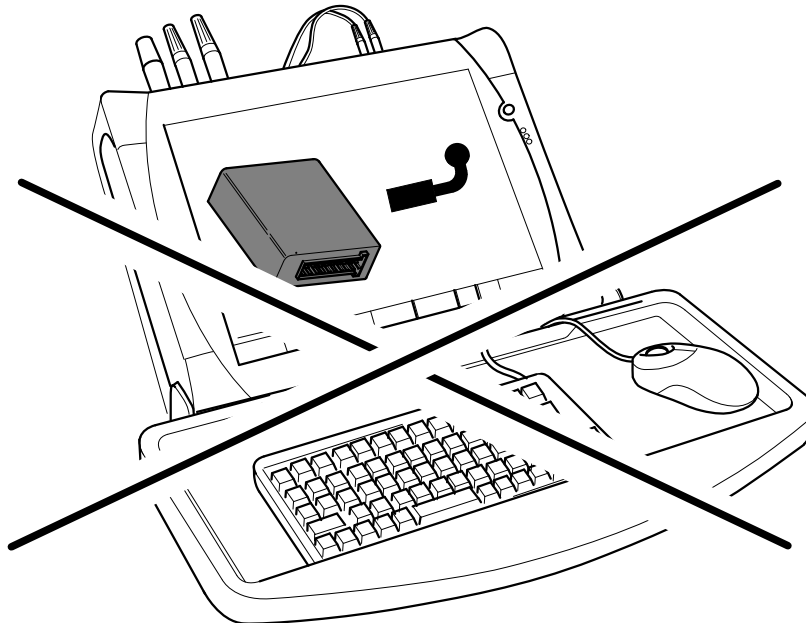

20 A

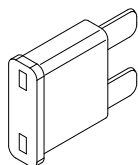
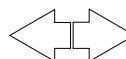
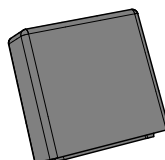
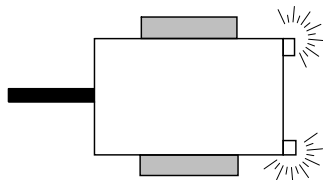

15 A

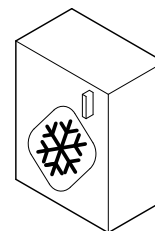
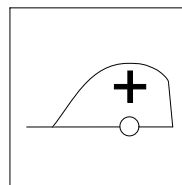
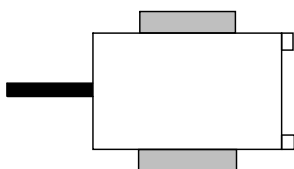

42

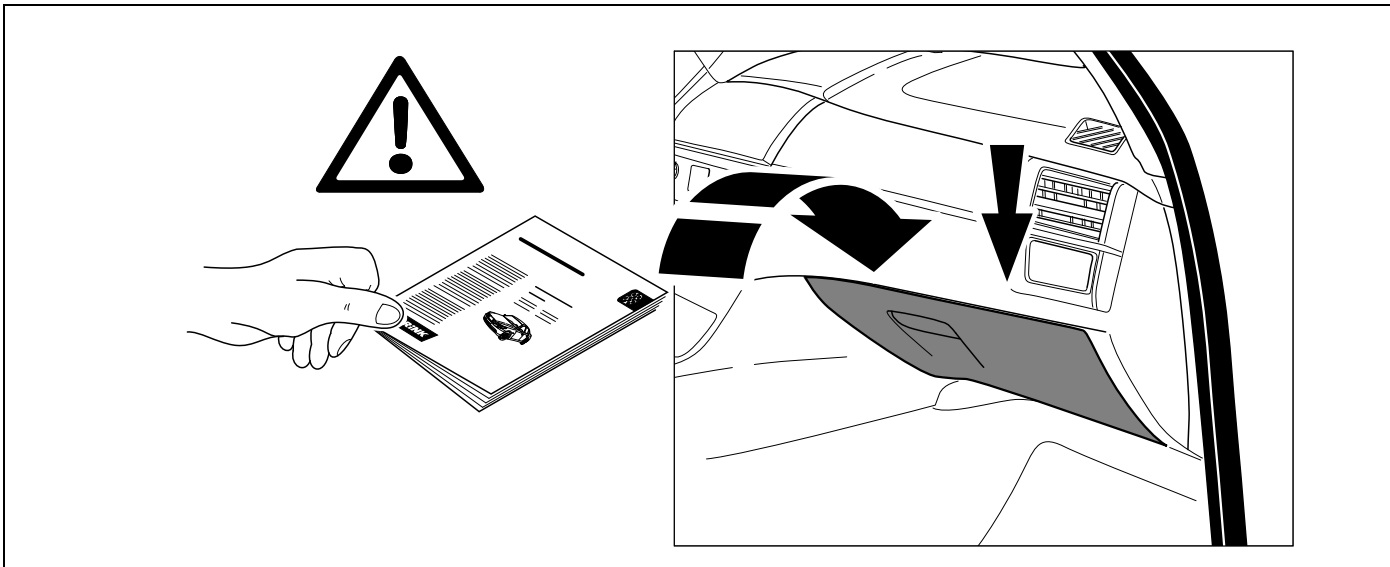

43

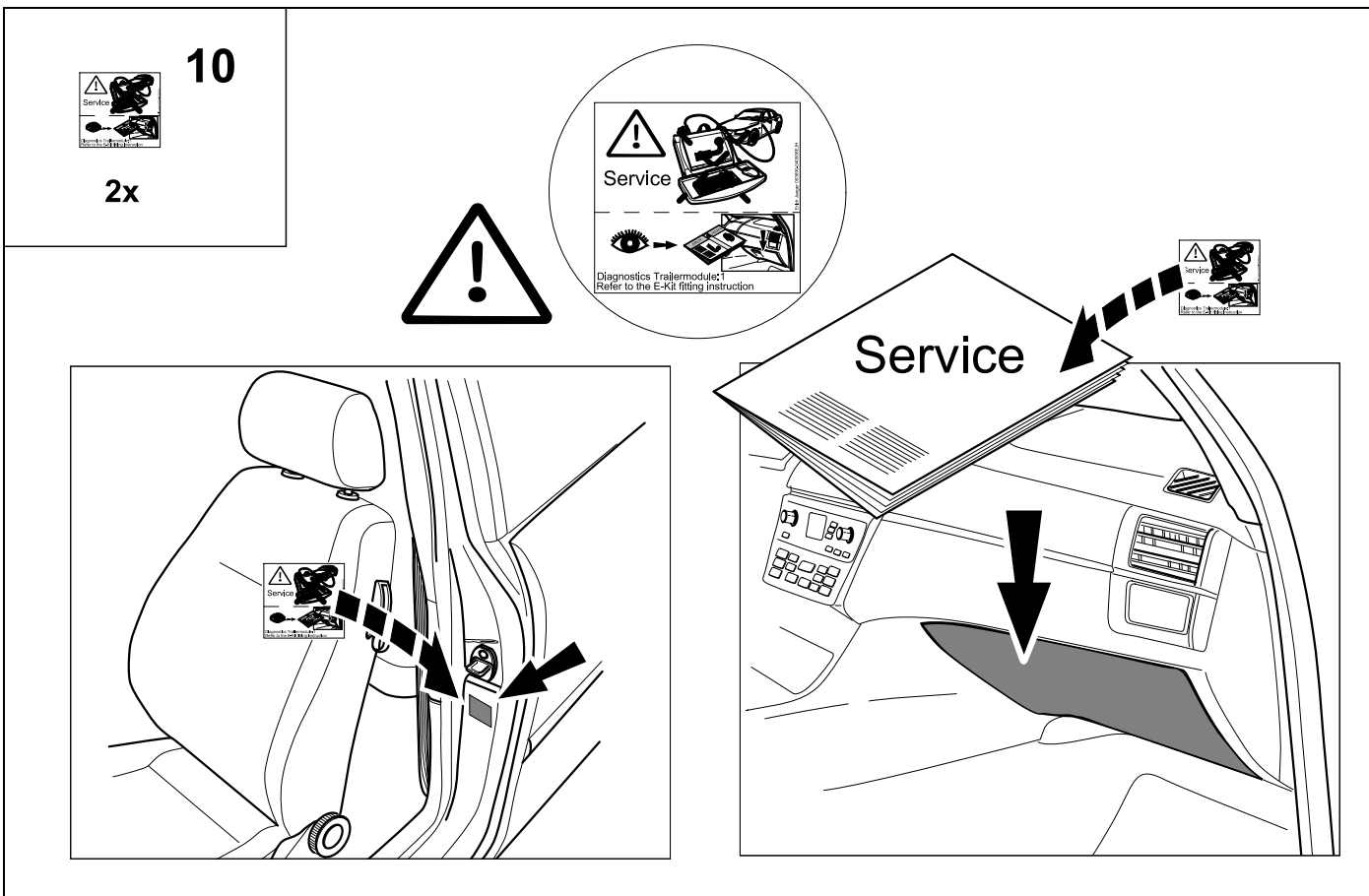

D	Änderungen bezüglich Konstruktion, Ausstattung Farbe sowie Irrtum vorbehalten. Angaben und Abbildungen unverbindlich	PL	Zastrzega się prawo do zmian dot. konstrukcji, wykończenia, kolorystyki oraz pomyłek. Dane i ilustracje niewiążące.
GB	Subject to change in terms of construction, equipment and colour, and may contain errors. The information and illustrations are non-binding.	TR	Tasarım, donanım ve renk bakımından deęişiklik yapma hakkı ve hata ve eksiklik mahfuzdur. Veriler ve resimler baęlayıcı deęildir.
F	ous r�serve de modifications de la construction, de �quipement, de la couleur et sous r�serve d'erreurs. Les indications et les illustrations sont sans engagement.	H	A szerkezet, a kivit�l �s a sz�n v�ltoztat�sa, valamint a v�ltoz�sok joga fenntartva. Az adatok �s az �br�k nem k�telez� �rv�ny�ek.
NL	Wijzigingen met betrekking tot constructie, uitvoering en kleur evenals vergissingen voorbehouden. Gegevens en afbeeldingen niet bindend.	HR	Pravo promjena u svezi konstrukcije, opreme, boje kao i zabune oridzavamo. Podaci i ilustracije su neobavezne.
DK	�ndringer med hensyn til konstruktion, udstyr, farver samt fejl forbeholdes. Oplysninger og illustrationer er uforpligtende.	BUL	Запазени права по отношение на конструкцията, обзавеждането, цвета и грешки. Данните и изображенията не са обвързващи.
N	Endringer ang�ende konstruksjon, utstyr, farge og feiltagelse forbeholdes. Oplysninger og illustrasjoner uforbindtlig.	RO	Ne rezerv�m dreptul unor modific�ri ale construc�iei, dot�rii, culorii �i dreptul la erori Datele indicate �i imaginile sunt orientative.
S	Med reservation f�r �ndringar vad det g�ller konstruktion, utrustning, f�rg samt f�r misstag. Uppgifterna och bilderna �r inte bindande.	RU	Права на внесение изменений относительно конструкции, оснащения, окраски, а также на ошибки сохраняются. Данные и иллюстрации имеют примерный характер.
FIN	Pid�t�mme oikeuden rakennetta, varustusta, v�ri� koskeviin sek� erehdyksest� johtuviin muutoksiin. Tiedot ja kuvat eiv�t ole sitovia.	LT	Pasilieikama konstrukcijos, įrangos bei reikmenų, spalvos pakeitimų ir klaidų teis�. Duomenys ir iliustracijos neįpareigojantys.
I	Con riserva di modifiche relative a progettazione, dotazione, colore ed errori. Le indicazioni e figure sono fornite senza impegno.	LV	Tiek patur�tas ties�bas uz konstrukcijas, iek�rtu, kr�su izmaiņam, k� �r� k�l�dišanasos. Dati un att�li bez saist�b�m.
E	Reservadas las modificaciones respecto a dise�o, equipamiento, color, as� como error. Indicaciones y figuras sin compromiso.	EST	Konstruktsiooni, varustuse ja v�rvi osas muudatud ning eksimine lubatud. Andmed ja joonised on mittesiduvad.
P	Reservamos o direito de altera��es relativamente ao desenho, equipamento, cor, bem como de erro. Os dados e as gravuras n�o implicam compromisso da nossa parte.	SLO	Zadrzana pravica do sprememb glede konstrukcije, opreme, barve ter pomote. Podatki in slike so neobvezne.
GR	�iatup�noume k�θε επιφ�λαξη ως προς αλλαγ�ς σε σ�εση με κατασκευ�, εξοπλισμ�, διαρρ�θμιση, χρωματισμ�ς και λ�θη παραδρομ�ς.	SK	Zmeny, ktor� sa t�kaj� konštrukcie, vybavenia, farby, ako aj omyly s� vyhraden�. �daje a zobrazenia s� nez�v�zn�.
CZ	Zm�ny, t�kaj�c� se konstrukce, vybaven�, barvy, jakoř i omyly jřou vyhrazeny. �daje a vyobrazen� jsou nez�v�zn�.		