

NL Montage-instructies
DE Montageanleitung
GB Fitting instructions
FR Instructions de montage
IT Istruzioni per il montaggio
ES Instrucciones de montaje
SE Monteringsanvisning

FI Asennusohje
PL Instrukcja montażu
CZ Návod na montáž
DK Monteringsvejledning
NO Monteringsanvisning
GR οδηγίες συναρμολόγησης



738491

Peugeot 5008 11/09 -

Follow me...

NL De onderneming kan niet aansprakelijk worden gesteld voor schade indien de instructies die bij de kabelsets worden geleverd niet worden gerespecteerd.
Belangrijk: niet overschrijden van het maximale vermogen wordt aangegeven door de functie "Tab. A"

DE Das Unternehmen kann nicht verantwortlich für entstandenen Schaden zu halten, wenn die Möbel Anweisungen, die der Anhängerkupplungen Verdrahtungssätze eingehalten werden nicht gestellt.
Wichtig: ragen Sie nicht heraus die maximale Kraft wird durch die Funktion " Tab. A "

GB The company cannot be responsible for any damage if the instructions of accessories supplied with the towbars wiring kits are not respected.
Important: Do not exceed the maximum power indicated on "Tab. A"

FR La société ne peut pas être responsable de tout dommage si les instructions d'accessoires fournis avec les kits de câblage attelages ne sont pas respectés.
Important : Ne pas dépasser la puissance maximale par fonction indiquée sur " Tab. A "

IT La società, non possono essere tenuti responsabili di eventuali danni, se le istruzioni accessori fornite con il kit towbars cablaggio non sono rispettati.
Importante: Non superare la potenza massima indicata dalla funzione "Tab. A"

ES La empresa no puede ser considerada responsable de ningún daño que pueda, si las instrucciones de los accesorios previstos con los kits de cableado de ganchos de remolque no se respetan
Importante: No sobrepasar la potencia máxima indicada por la función "Tab. A"

SE Företaget kan inte hålla ansvariga den damage om inredning anvisningarna med dragkrokar Kabelsats inte respekteras.
Viktigt: Överskrid inte den maximala effekt som anges av funktionen "Tab. A"

FI Yhtiö ei voida pitää vastuussa kaikista damage jos liitos mukana toimitettuja ohjeita Vetokoukku johtosarja ei noudateta.
Tärkeää: Älä ylitä ilmaiseaman tehon toiminto "Tab. A"

PL Firma nie może być pociąganie do odpowiedzialności wszystkich damage jeśli armatura instrukcją dołączoną do haków holowniczych zestawu przewodów nie są przestrzegane.
Ważne: Nie należy przekraczać maksymalnej mocy wskazane przez funkcję "Tab. A"

CZ Společnost nelze volat k zodpovědnosti, pokud z jakýchkoli damage kování s pokyny vedení tažných zařízení soupravy nejsou dodržovány.
Důležité upozornění: Nepřekračujte maximální výkon udávaný funkci "Tab. A"

DK Firmaet kan ikke drages til ansvar for nogen damage hvis fittings anvisninger med anhængertræk wiring kits er ikke overholdes.
Vigtigt: Du må ikke overstige den maksimale effekt angives med funktionen "Tab. A"

NO Selkapet ikke kan holde ansvarlig for eventuelle damage dersom inventar instruksjoner følger med towbars ledningsnett blir ikke respektert.
Viktig: Du må ikke overstige den maksimale effekt angitt av funksjonen "Tab. A"

GR η εταιρεία μπορεί να μην κατέχει υπεύθυνη για κάθε damage εάν οι οδηγίες που παρέχονται με εξαρτήματα τα towbars και καλωδίωση δεν γίνονται σεβαστά.
Σημαντικό: Μην υπερβαίνετε τη μέγιστη ένδειξη ισχύος λειτουργία "Tab. A"

FR Liste de pièces

NL Onderdelenlijst

SE Dellista

CZ Seznam dílů

G Part list

IT Elenco componenti

FI Osaluettelo

D Del-liste

DE Einzelteilliste

ES Lista de componentes

PL Lista części

N Delliste

G λίστα συνιστώσα

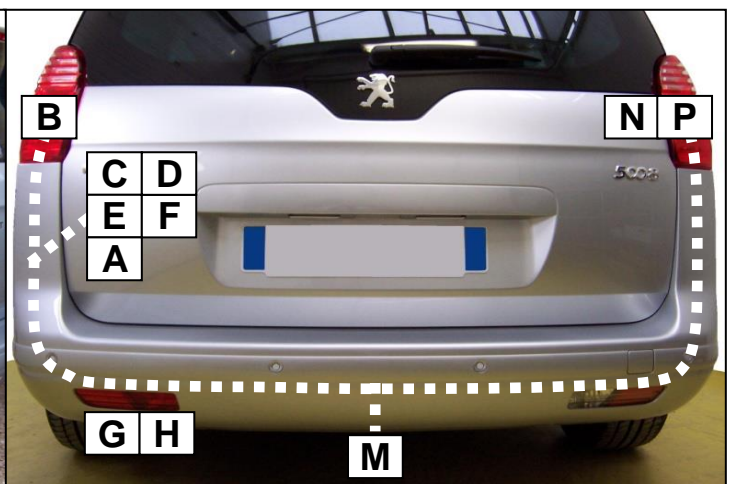
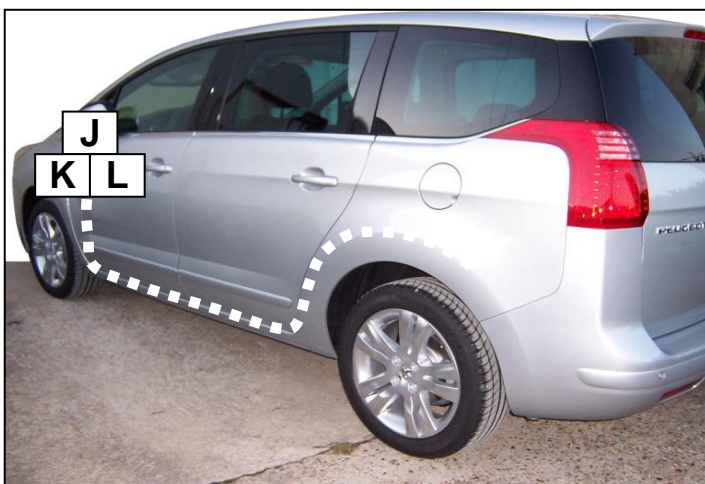
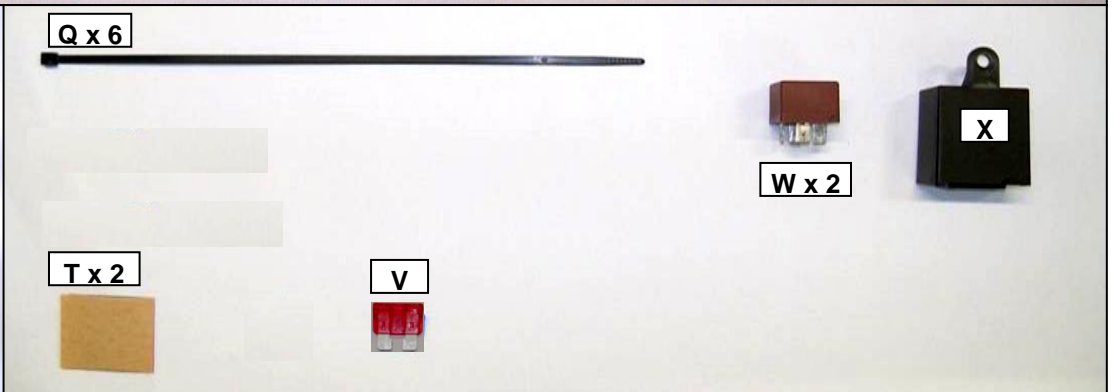
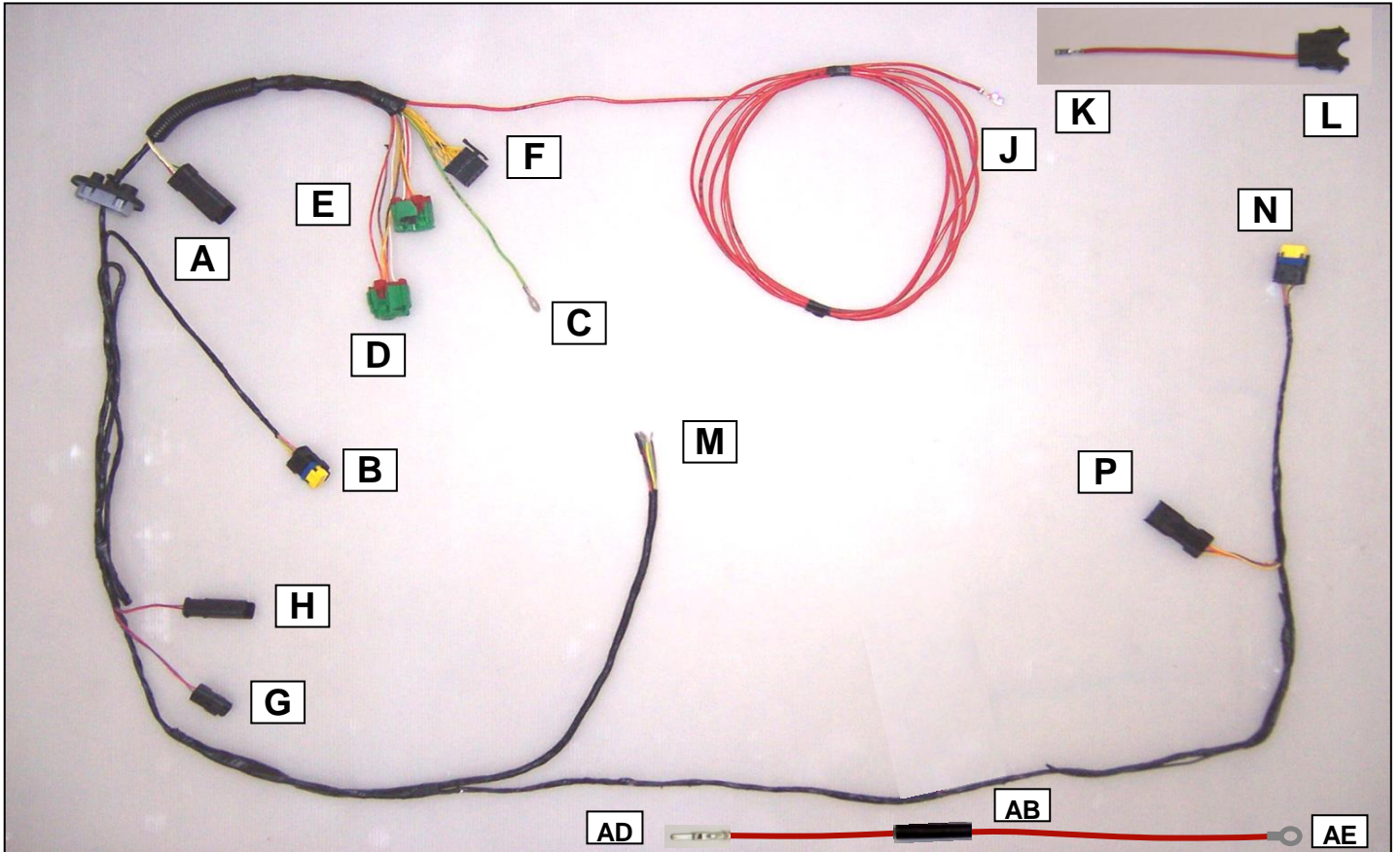

Cette notice ne peut être divulguée ou reproduite, partiellement ou en totalité, sans accord de la société.
 This fitting instructions can not be disclosed or reproduced, in part or in whole without permission of the company.

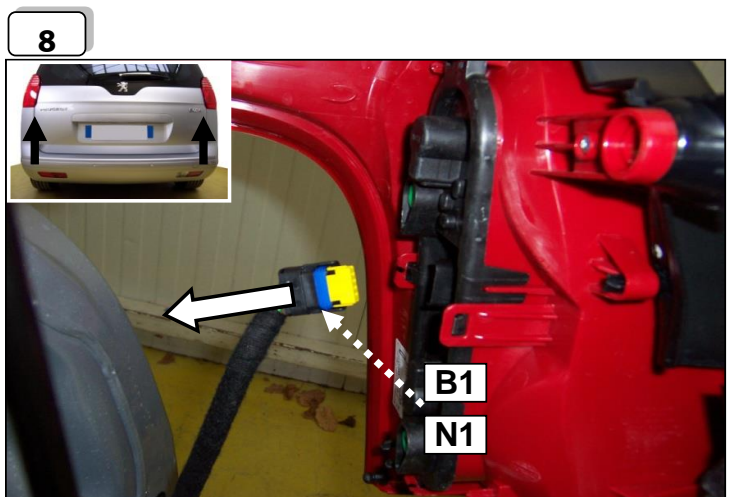
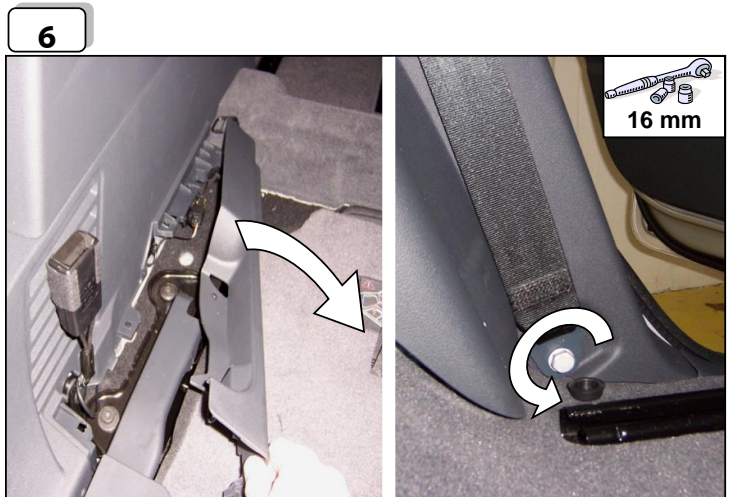
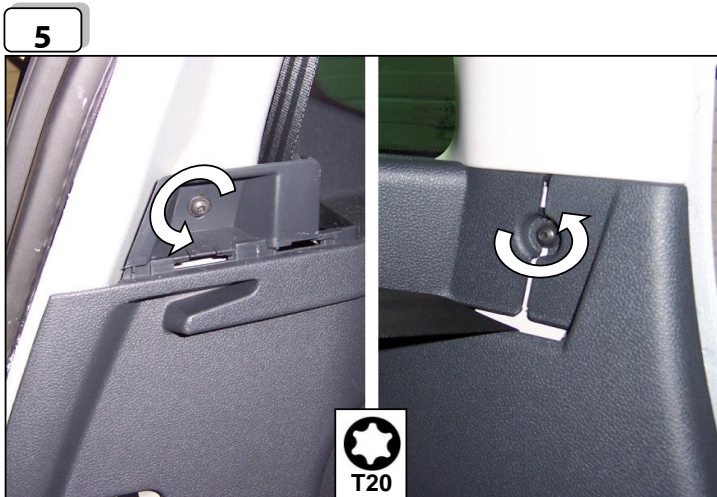
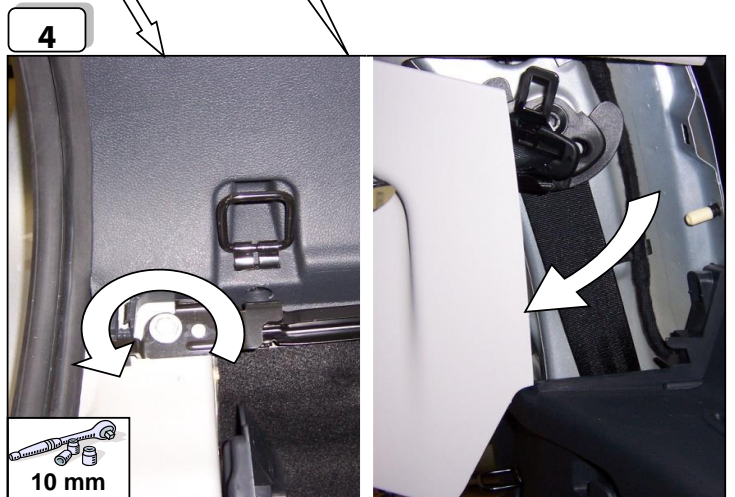
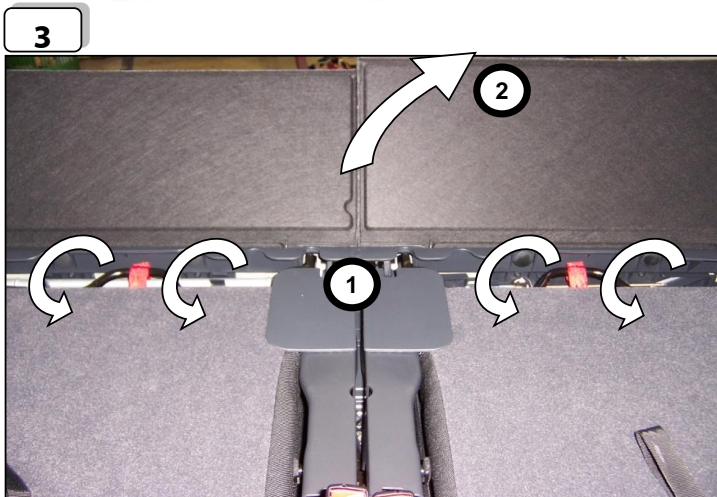
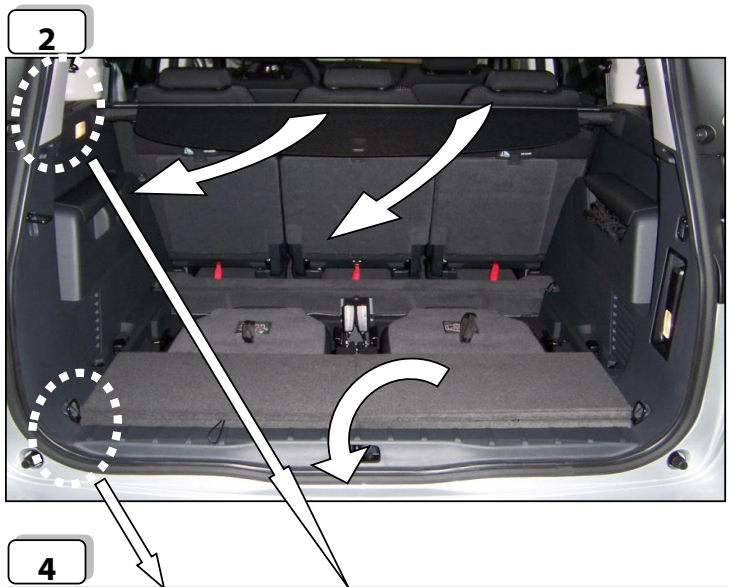
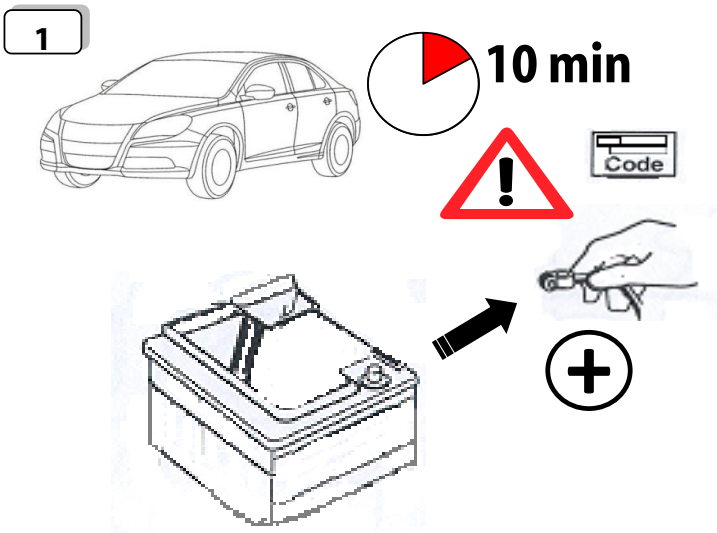

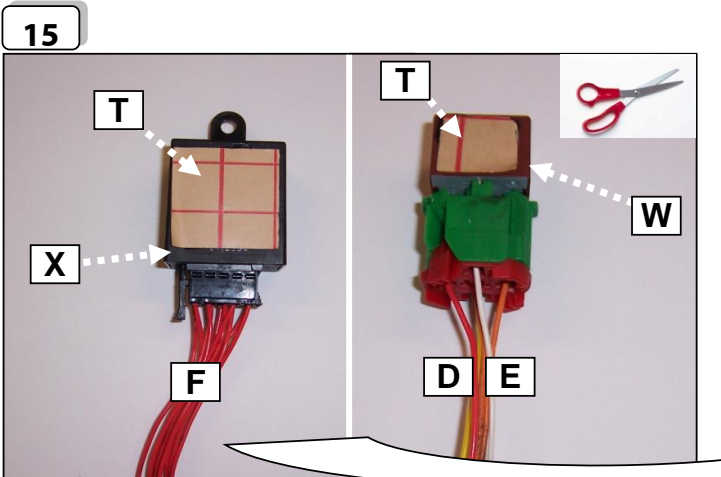
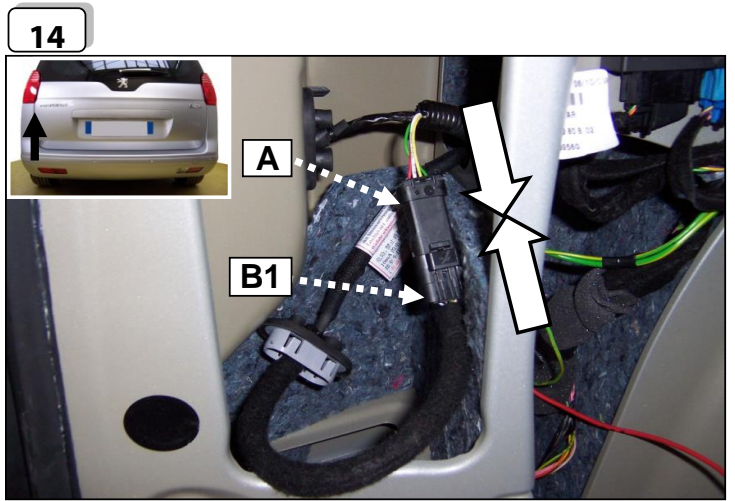
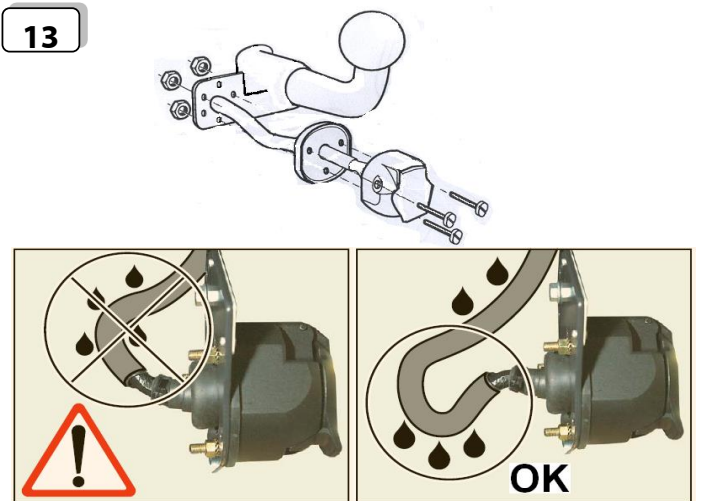
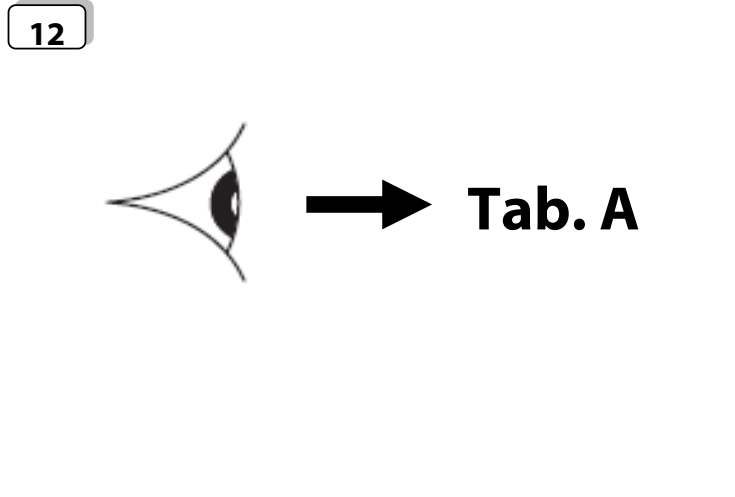
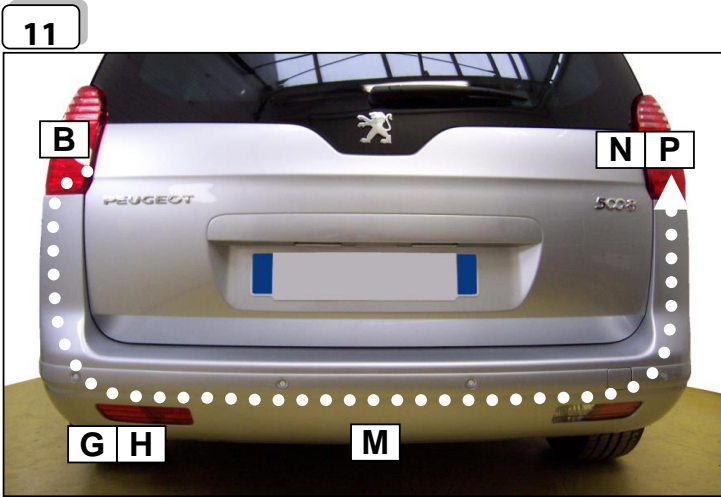
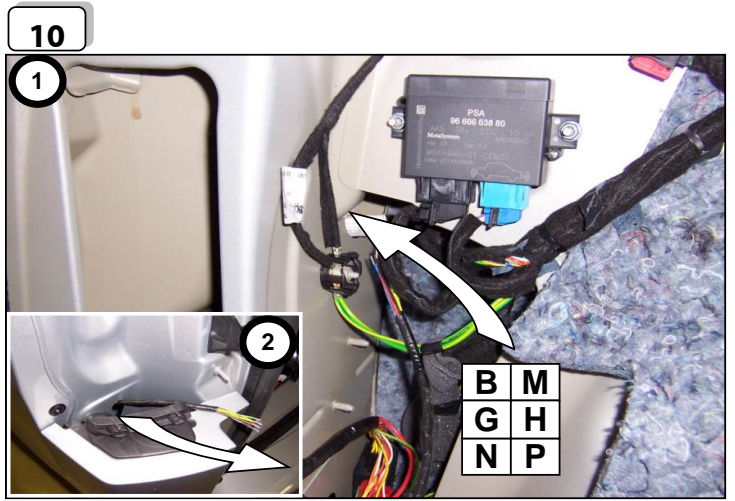

17

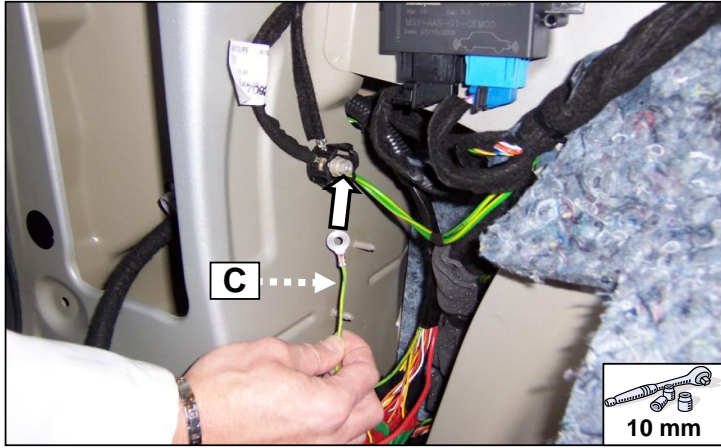

18

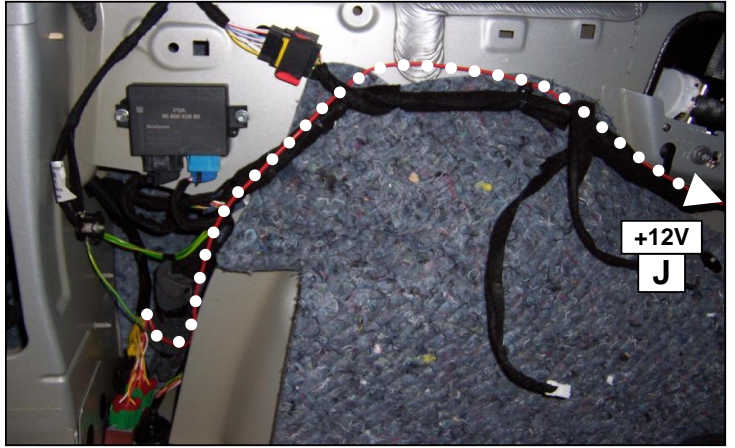

19



20



21

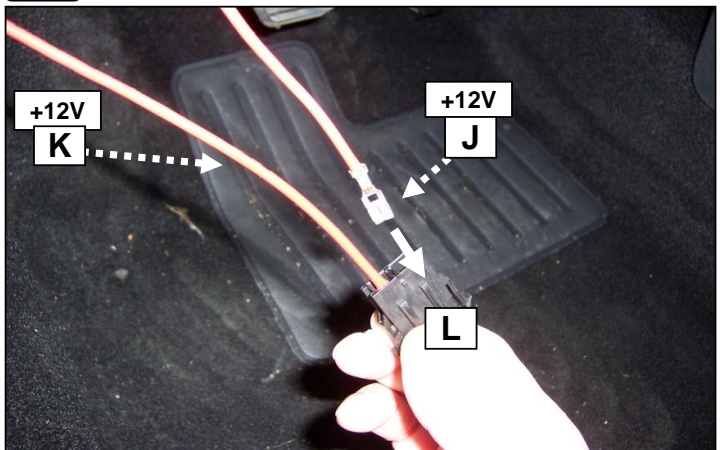

22

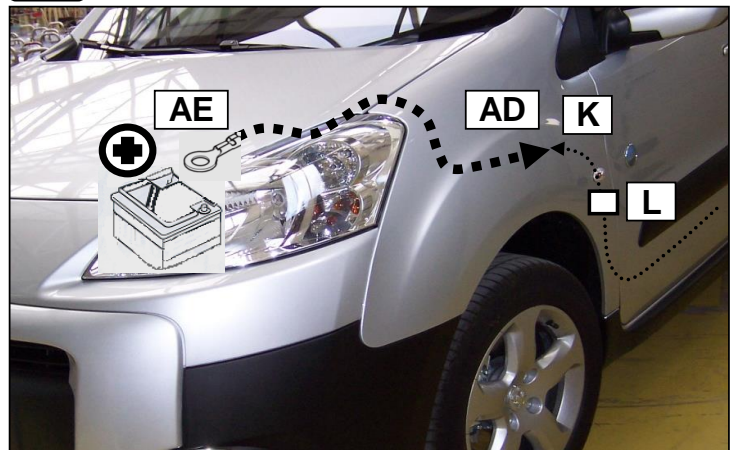

23

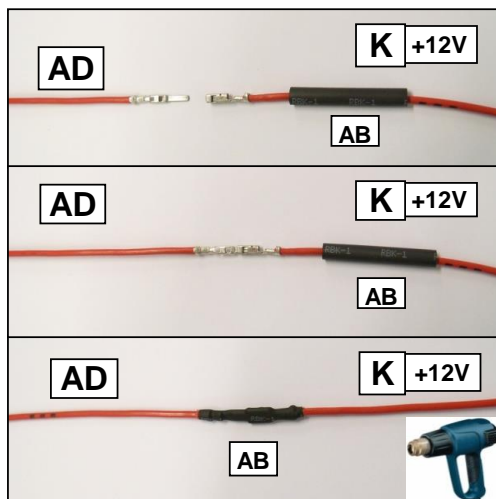

24

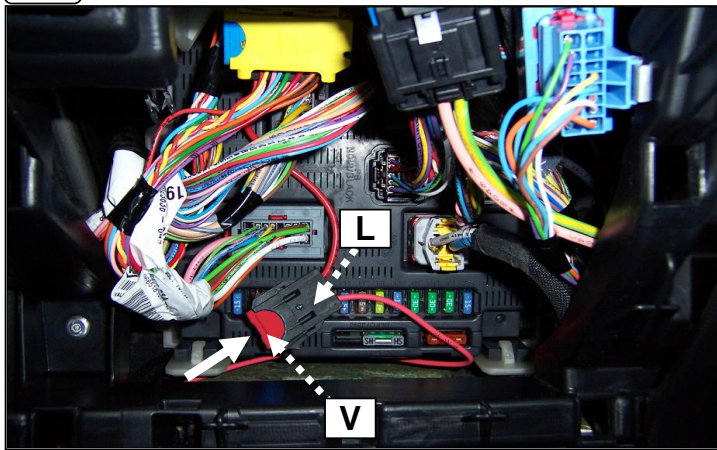

25

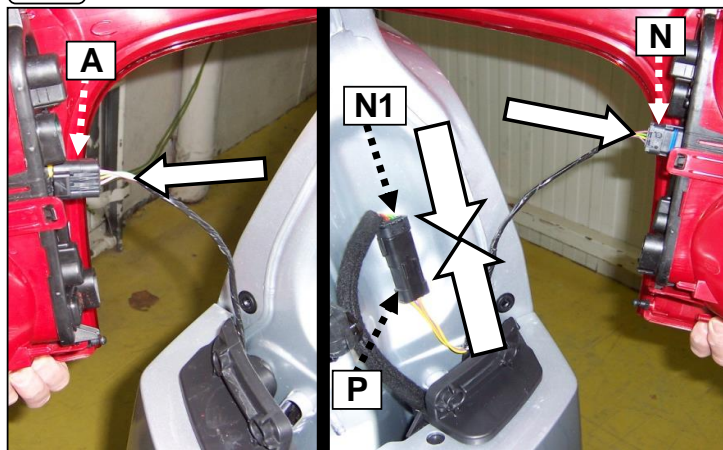

26

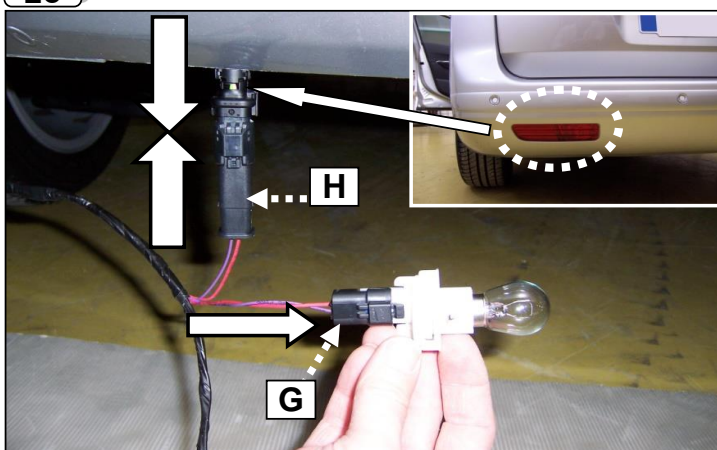

27

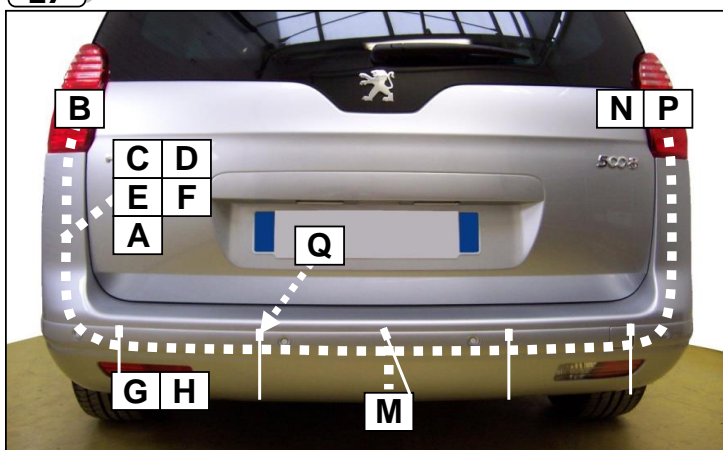

28



29

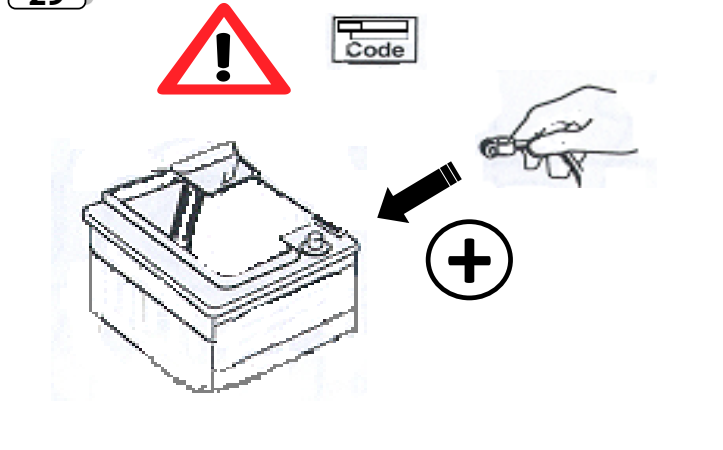

30

- (FR) Contrôler les fonctions
- (G) Check functions
- (DE) Funktionen kontrollieren
- (NL) Controleer functies
- (IT) Controllare le funzioni
- (ES) Controlar las funciones
- (SE) Kontrollera funktionerna
- (FI) Tarkista toiminnot
- (PL) Sprawdź funkcje
- (CZ) Ověřte funkce
- (D) Check funktionerne
- (N) Kontroller funksjonene
- (G) Ελεγχος των λειτουργιών



31



Lors du branchement de la remorque ,désactiver le système "RADAR DE REcul" au tableau de bord
When you connect the trailer, do remove the function "PARK ASSIST" on the dashboard

Tab. A

FR Connection de la prise	NL Contactdoos aansluiting	SE Anslutning kontaktdosa	CZ objímkový konektor
GB Socket connection	IT Allaccio zoccolo	FI Pistorasia liitäntä	DK Stikdåse forbindelse
DE Anschluss Steckdose	ES Conexión de la caja de enchufe	PL Polaczenie przez gniazdo	NO Tilkobling koblingsboks
			GR Υποδοχή σύνδεσης

	1 /L	2 /54G	3 /31	4 /R	5 /58R	6 /54	7 /58L	C
P max	21+5 W	21 W		21+5 W	40 W	63 W	40 W	
FR	Jaune	Bleu	Vert/Jaune	Vert	Marron	Rouge	Noir	Gris
GB	Yellow	Blue	Green/Yellow	Green	Brown	Red	Black	Grey
DE	Gelb	Blau	Grün/Gelb	Grün	Braun	Rot	Schwarz	Grau
NL	Geel	Blauw	Groen/Geel	Groen	Bruin	Rood	Zwart	Grijs
IT	Giallo	Blu	Verde/Giallo	Verde	Marrone	Rosso	Nero	Grigio
ES	Amarillo	Azul	Verde/Amarillo	Verde	Marron	Rojo	Negro	Gris
SE	Gul	Blå	Grön/Gul	Grön	Brun	Röd	Svart	Grå
FI	Keltainen	Sininen	Vihreä/Keltainen	Vihreä	Ruskea	Punainen	Musta	Harmaa
PL	Żółty	Niebieski	Zielony/Żółty	Zielony	Brązowy	Czerwony	Czarny	Szary
CZ	Žlutý	Modrá	Zelený/Žlutý	Zelený	Hnědý	Červený	Černý	Šedá
DK	Gul	Blå	Grøn/Gul	Grøn	Brun	Rød	Sort	Grå
NO	Gul	Blå	Grønn/Gul	Grønn	Brun	Rød	Svart	Grå
GR	κίτρινο	μπλε	πράσινο/κίτρινο	πράσινο	καφέ	κόκκινο	μαύρο	γκρι

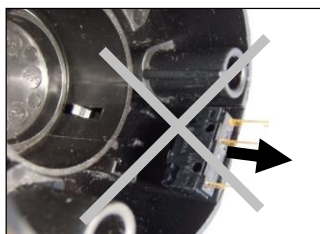

- FR** ne pas démonter le micro contacteur
- G** does not remove the micro switch
- DE** beseitigt nicht die Mikroschalter
- NL** neemt niet weg dat micro-schakelaar
- IT** non rimuovere il microinterruttore
- ES** no quita el micro interruptor
- SE** frångår inte mikrobrytare
- FI** ei poista mikrokkytkin
- PL** nie usuwa mikroprzełącznika
- CZ** neodstraní mikrosplínač
- D** fjerner ikke mikro switch
- N** fjerner ikke mikro bryteren
- G** δεν αίρει την μικροδιακόπτη

