

FR Instructions de montage du kit faisceau d'attelage avec prise 12-N conforme à la norme DIN/ISO1724.

GB Fitting instructions wiring kit tow bar with 12-N socket up to DIN/ISO Norm 1724.

DE Montageanleitung Verkabelungssatz Anhängerkupplung mit 12-N Steckdose für bis zu DIN / ISO 1724 Norm.

NL Montage-instructies bedrading trekhaak kit met 12-P contactdoos tot DIN / ISO Norm 1724.

IT Istruzioni di montaggio timone kit cablaggio con zoccolo a 12-N fino a DIN / Norma ISO 1724.

ES Instrucciones de montaje kit de cables de remolque con caja de conexiones 12-N de hasta DIN / Norma ISO 1724.

SE Monteringsanvisningar Kabelsats dragkrok med 12-N uttag upp till DIN / ISO-norm 1724.

FI Asennusohjeet johdotus Kit Vetokoukku kanssa 12-N-liittimeen jopa DIN / ISO Norm 1724.

PL Instrukcja montażu zestaw okablowania dyszel z 12-N do gniazda DIN / norma ISO 1724.

CZ Montážní pokyny vedení kit tažné zařízení s 12-N zásuvka do DIN / ISO 1724 Norm.

DK Monteringsvejledning wiring kit tow bar med 12-N-stikket op til DIN / ISO Norm 1724.

NO Fitting instruksjoner wiring kit tow bar med 12-N kontakten opp til DIN / ISO 1724 Norm.

GR Οδηγίες τοποθέτησης ζεύξης πορείας σεντ με δύναμη 12-N συμμορφούμενα DIN/ISO1724.

Peugeot 308 / 308SW ph2

Model : 5 doors

Year : 10/2013 →

Réf : 232083



0 h 45



FR LEONI a le droit de modifier le produit sans notification afin de garantir la satisfaction optimale de la clientèle.
LEONI ne peut pas être tenu responsable de tout dommage si les instructions de montage fournies avec les kits faisceaux attelage ne sont pas respectées.
Important : Ne pas dépasser la puissance maximale par fonction indiquée sur "Tab. B"

GB LEONI has the right to change the product without notification in order to guarantee customer optimal satisfaction.
LEONI can not be hold responsible of any damage if the fittings instructions provided with the towbars wiring kits are not respected.
Important: Do not exceed the maximum puissance function indicated "Tab. B"

DE LEONI hat das Recht, das Produkt ohne vorherige Mitteilung zu ändern, um Kunden optimale Zufriedenheit zu gewährleisten.
LEONI kann nicht verantwortlich für entstandenen Schaden zu halten, wenn die Möbel Anweisungen, die der Anhängerkupplungen Verdrahtungssätze eingehalten werden nicht gestellt.
Wichtig: Überschreiten Sie nicht die maximale Leistung angegeben nach der Funktion "Tab. B"

NL LEONI heeft het recht om het product te wijzigen zonder kennisgeving om de klant een optimale tevredenheid te garanderen.
LEONI kan niet aansprakelijk van damage indien de armaturen instructies die bij de trekhaken kabelsats worden niet gerespecteerd.
Belangrijk: niet overschrijden van het maximale vermogen wordt aangegeven door de functie "Tab. B"

IT LEONI ha il diritto di modificare il prodotto senza notifica al fine di garantire la soddisfazione del cliente ottimale.
LEONI, non possono essere tenuti responsabili di eventuali danni, se le istruzioni accessori fornite con il kit towbars cablaggio non sono rispettati.
Importante: Non superare la potenza massima indicata dalla funzione "Tab. B"

ES LEONI tiene el derecho a cambiar el producto sin necesidad de notificación a fin de garantizar la satisfacción del cliente óptimo.
LEONI no puede ser considerada responsable de ningún daño que pueda, si las instrucciones de los accesorios previstos con los kits de cableado de ganchos de remolque no se respetan
Importante: No sobrepasar la potencia máxima indicada por la función "Tab. B"

SE LEONI har rätt att ändra produkten utan anmälan för att garantera kunderna en optimal uppfyllelse.
LEONI kan inte hålla ansvariga den damage om inredning anvisningarna med dragkrokar Kabelsats inte respekteras.
Viktigt: Överskrid inte den maximala effekt som anges av funktionen "Tab. B"

FI LEONI on oikeus muuttaa tuotetta ilman ilmoitusta takaamiseksi asiakkaiden optimaalista tyytyväisyyttä.
LEONI ei voida pitää vastuussa kaikista damage jos liitos mukana toimitettuja ohjeita Vetokoukku johtosarja ei noudateta.
Tärkeää: Älä ylitä ilmaiseaman tehon toiminto "Tab. B"

PL LEONI ma prawo do zmiany produktu bez powiadomienia w celu zapewnienia optymalnego zadowolenia klienta.
LEONI nie może być pociąganie do odpowiedzialności wszystkich damage jeśli armatura instrukcja dołączonej do haków holowniczych zestawu przewodów nie są przestrzegane.
Ważne: Nie należy przekraczać maksymalnej mocy wskazane przez funkcję "Tab. B"

CZ LEONI má právo na změnu výrobku bez oznámení, aby byla zaručena optimální spokojenosti zákazníka.
LEONI nelze volat k zodpovědnosti, pokud z jakýchkoli damage kování s pokyny vedení tažných zařízení soupravy nejsou dodržovány.
Důležité upozornění: Nepřekračujte maximální výkon dle funkce "Tab. B"

DK LEONI har rett til at ændre produktet uden anmeldelse for at sikre kunderne optimal tilfredsstillelse.
LEONI kan ikke holde ansvar for nogen damage hvis fittings anvisninger med anhængertræk wiring kits er ikke overholdes.
Vigtigt: Du må ikke overstige den maksimale effekt angives med funktionen "Tab. B"

NO LEONI har rett til å endre produktet uten varsel for å sikre kunden optimal tilfredsstillelse.
LEONI ikke kan holde ansvarlig for eventuelle damage dersom inventar instruksjoner følger med towbars ledningsnett blir ikke respektert.
Viktig: Du må ikke overstige den maksimale effekt angitt av funksjonen "Tab. B"

GR LEONI έχει το δικαίωμα να τροποποιήσει το προϊόν δεν κοινοποίηση να εξασφαλίσει η βέλτιστη ικανοποίηση των πελατών.
LEONI δεν μπορεί να είναι υπεύθυνη για οποιαδήποτε ζημία εάν οι οδηγίες που συνοδεύουν το εξάρτημα καλωδίωσης kit δεν γίνονται σεβαστά.
Σημαντικό: Μην υπερβαίνετε τη μέγιστη ένδειξη ισχύος λειτουργία "Tab. B"

FR Liste de pièces

NL Onderdelenlijst

SE Dellista

CZ Seznam dílů

G Part list

IT Elenco componenti

FI Osaluettelo

D Del-liste

DE Einzelteilliste

ES Lista de componentes

PL Lista części

N Delliste

G λίστα συνιστώσα

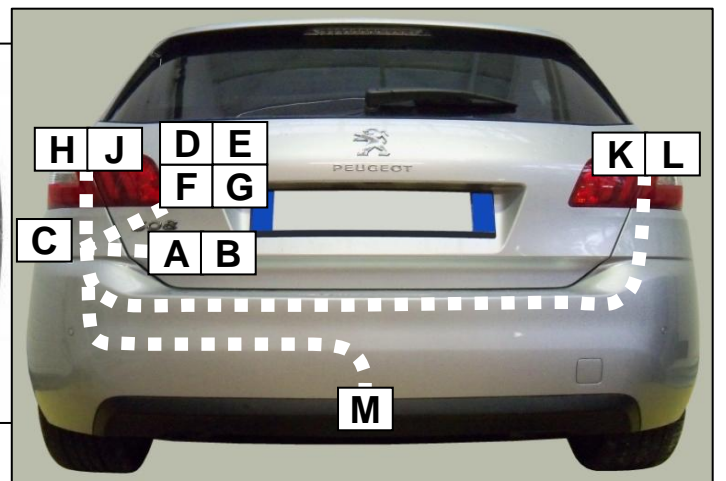
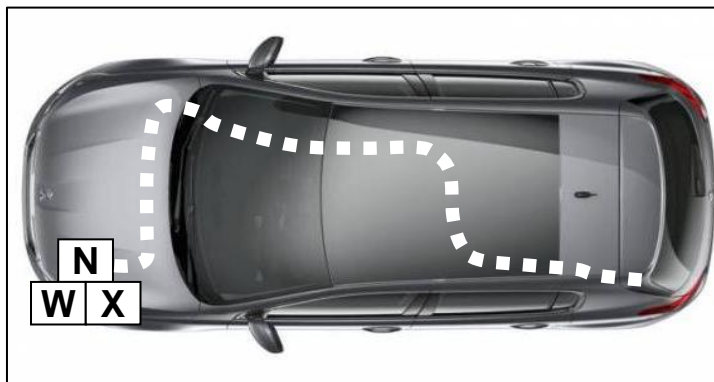
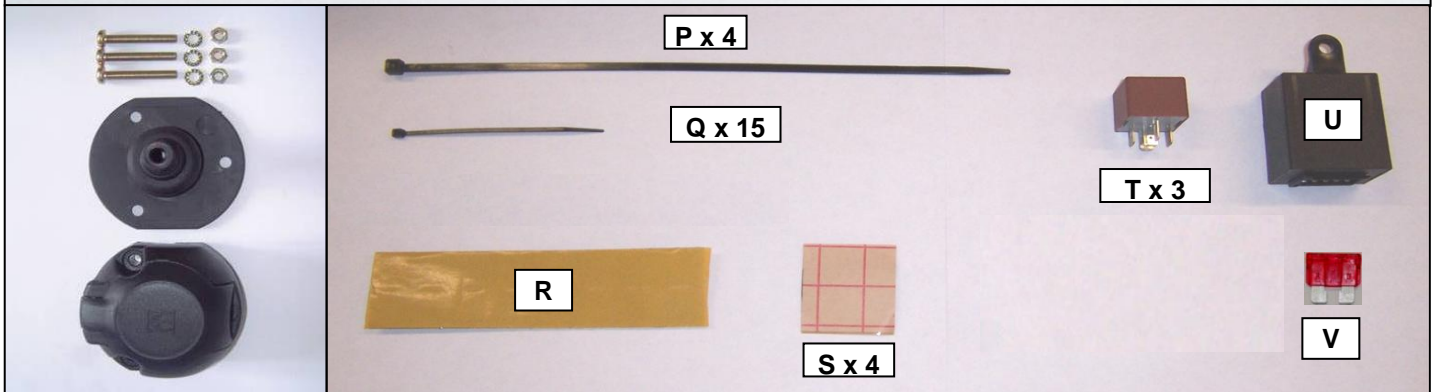
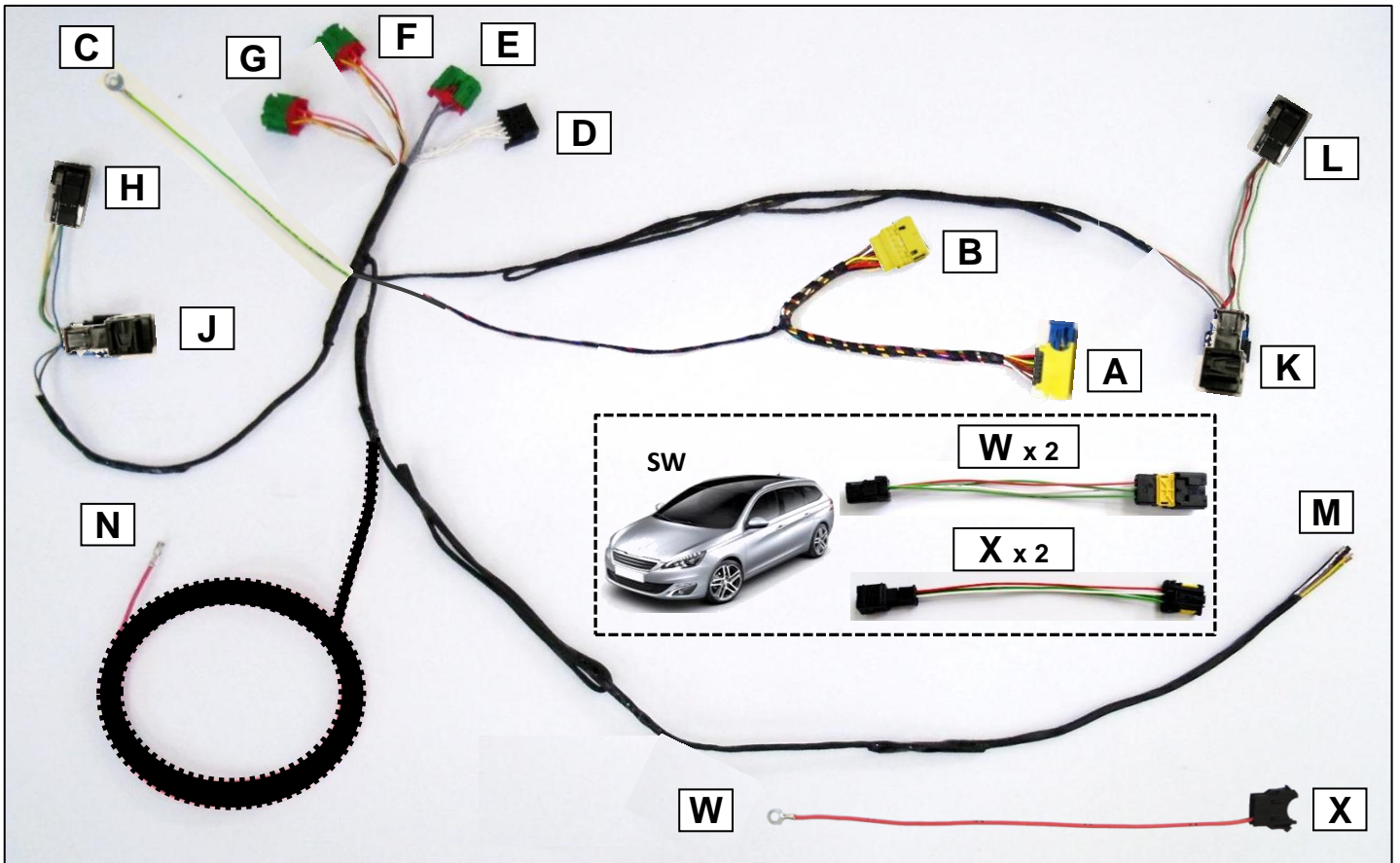

Cette notice ne peut être divulguée ou reproduite, partiellement ou en totalité, sans accord de la société.
 This fitting instructions can not be disclosed or reproduced, in part or in whole without permission of the company.

1

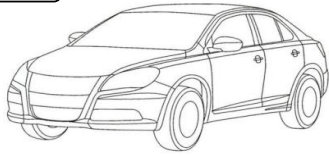

10 min

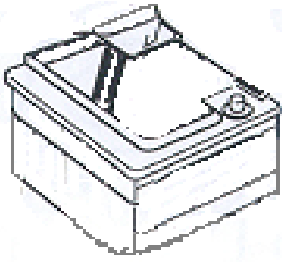

7



2



8



3



9





4

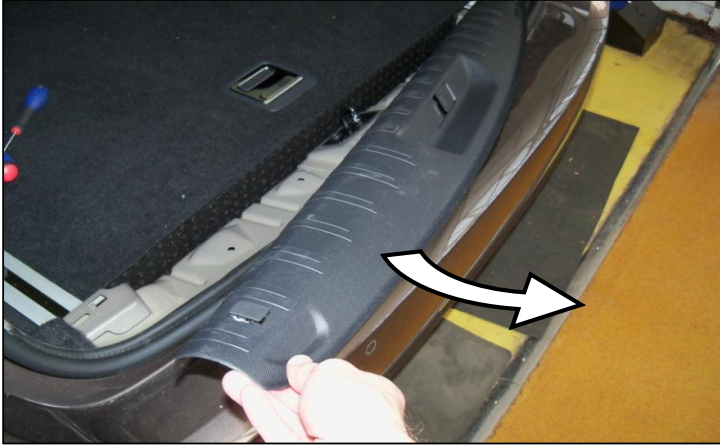

10



5



11

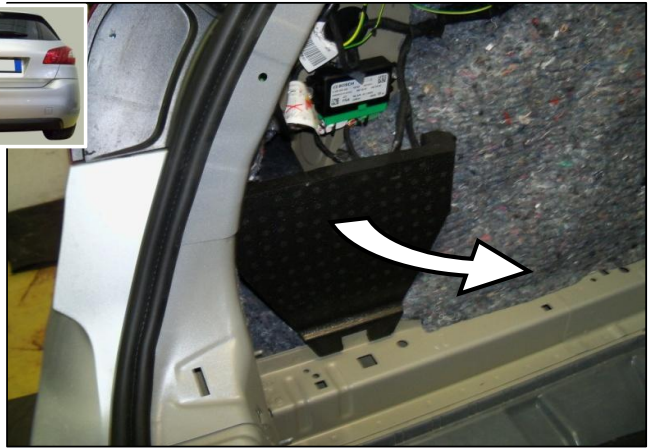

6



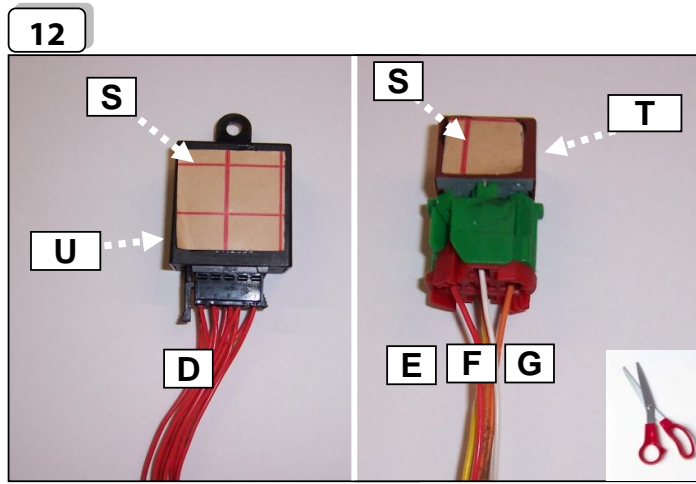

13

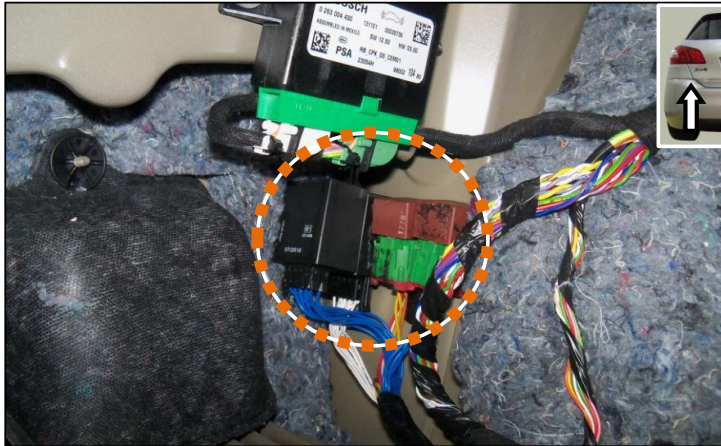

15



14

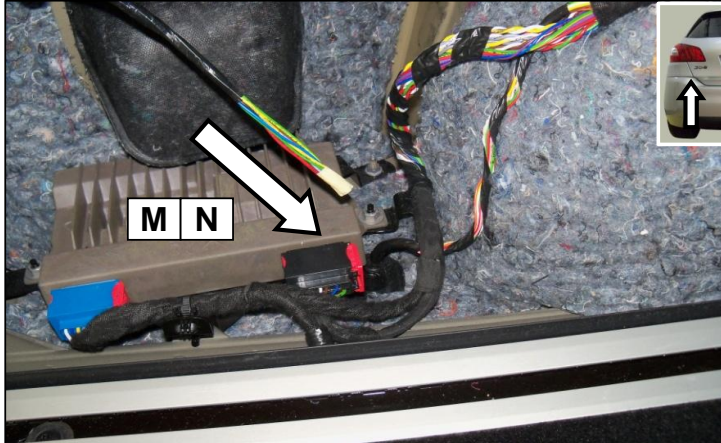

16

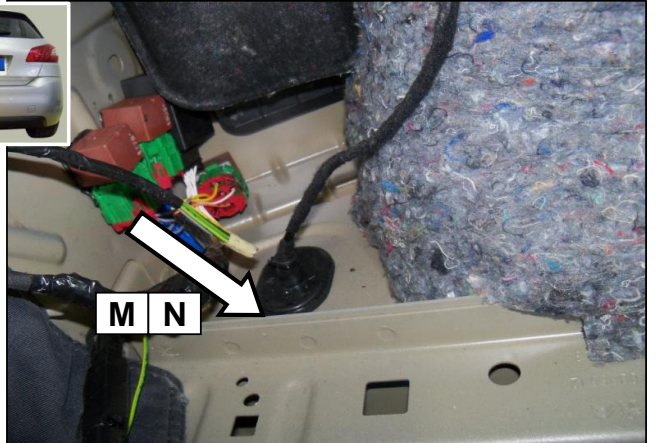

17

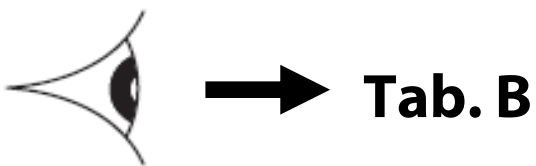

18

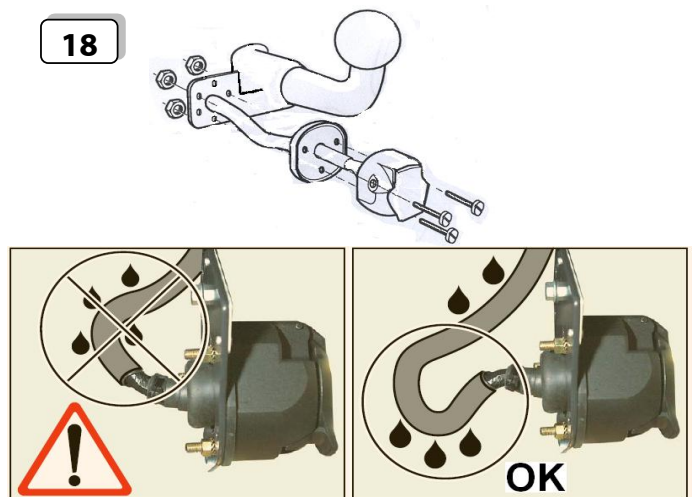

19

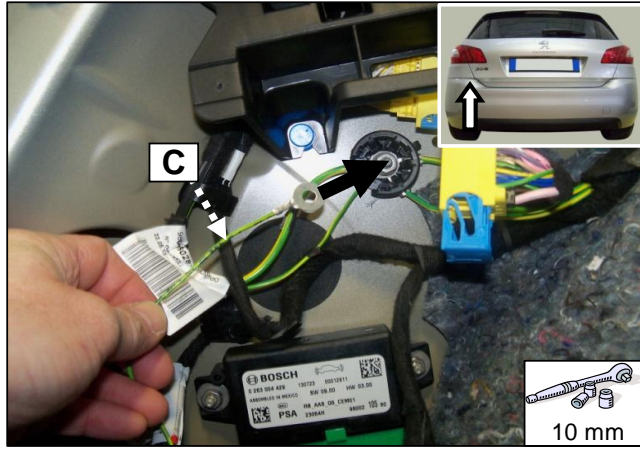

20

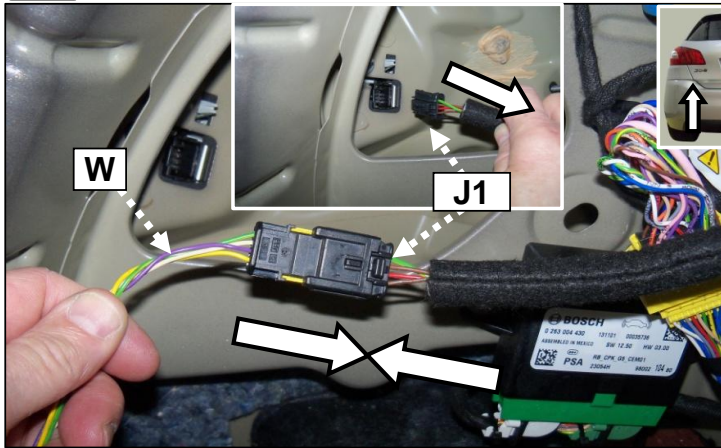

23

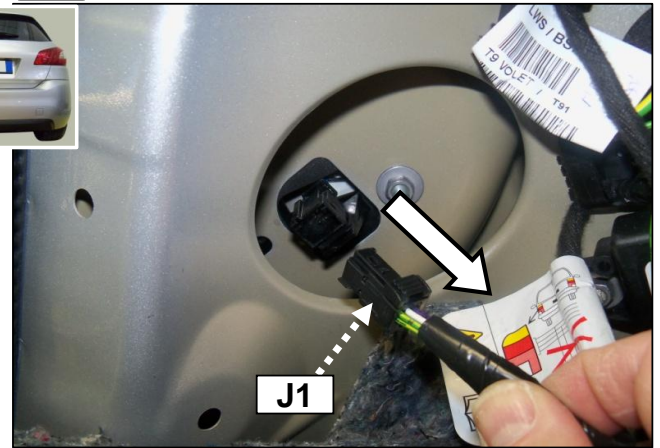

21

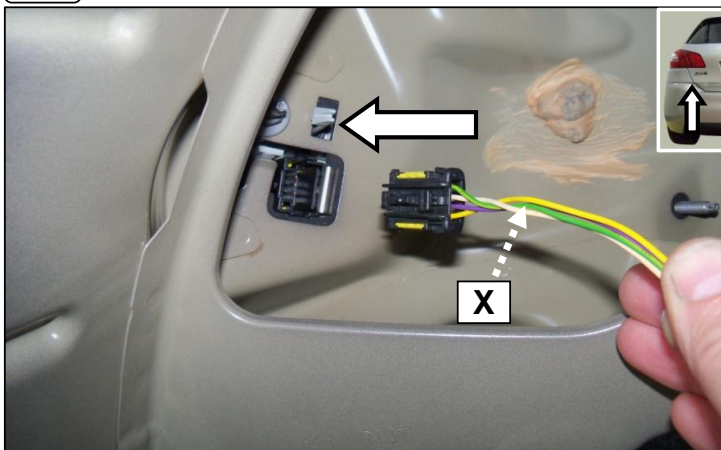

24

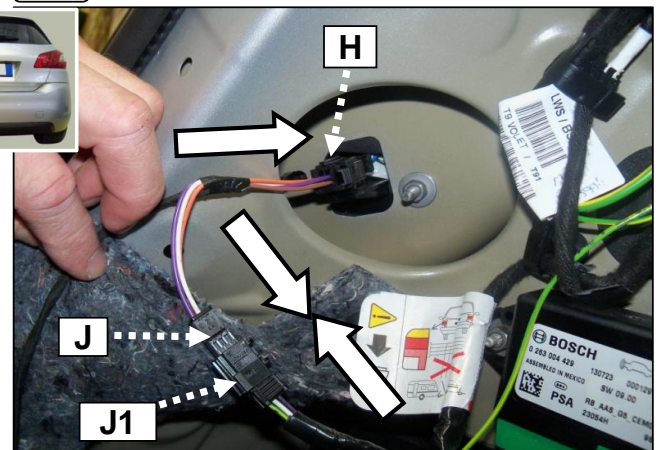

22

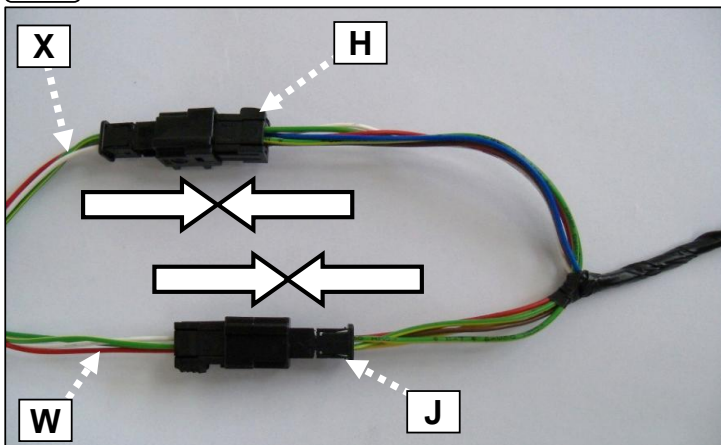

25

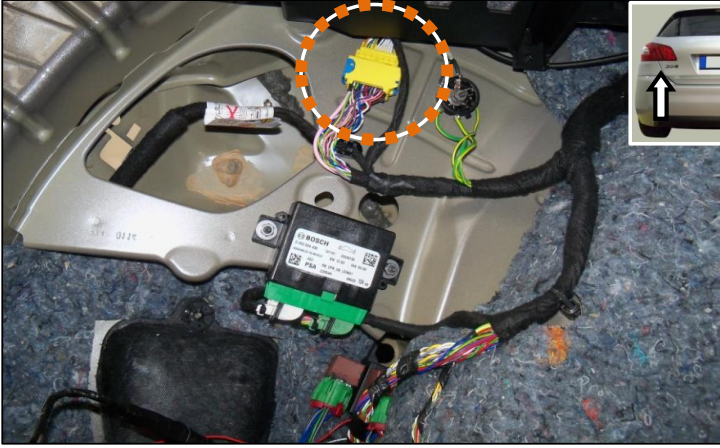

26

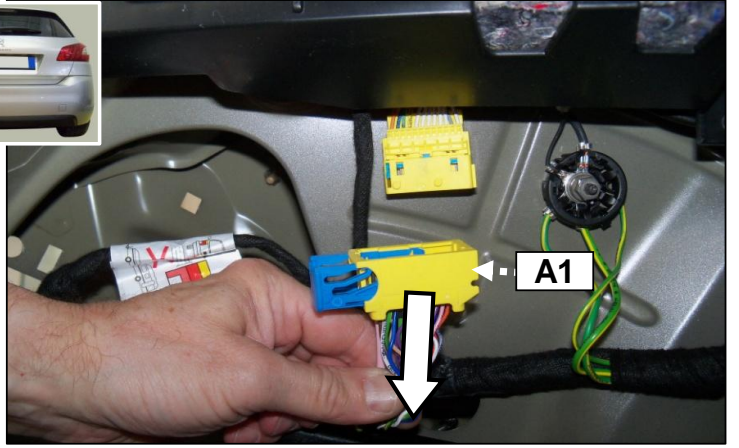

27

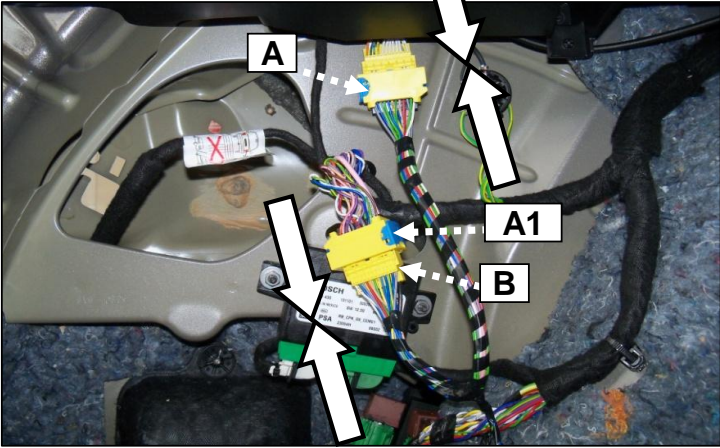

28

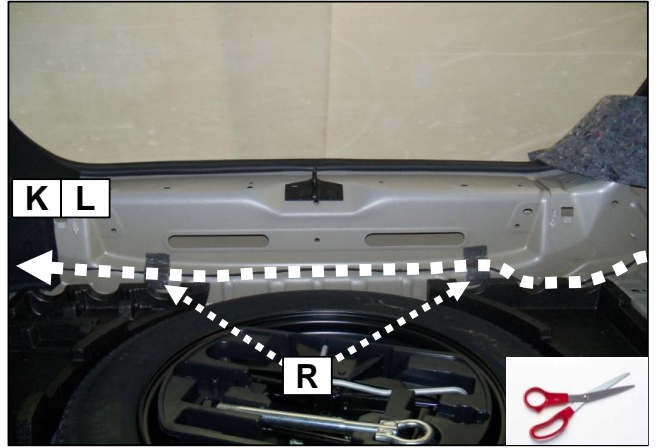

29

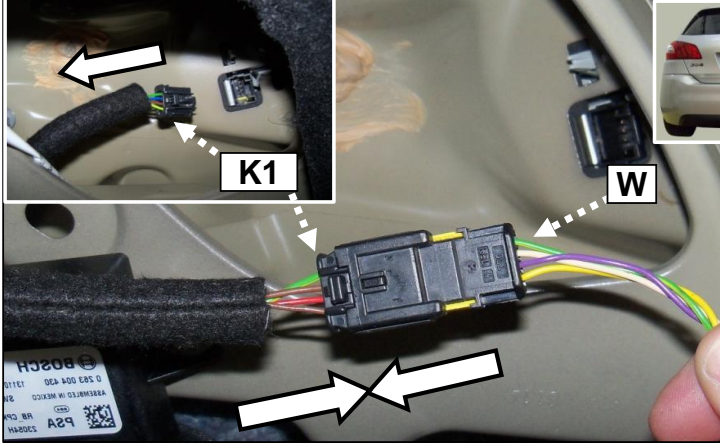

32

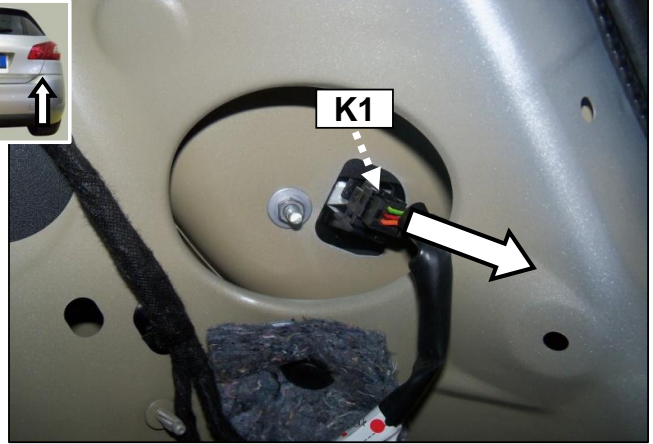



30

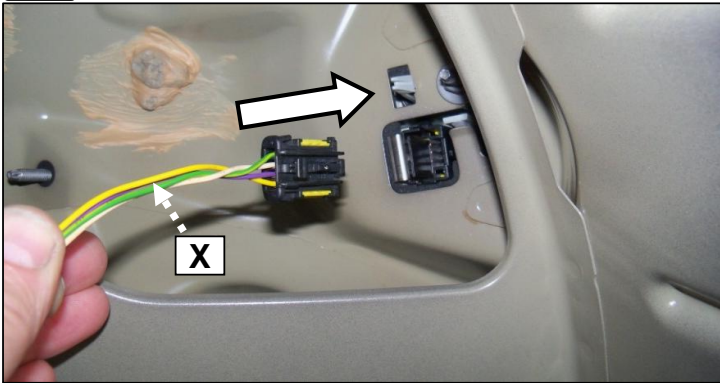

31

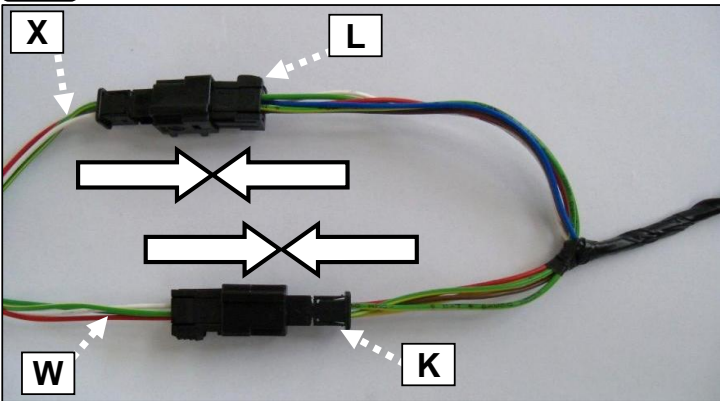

34

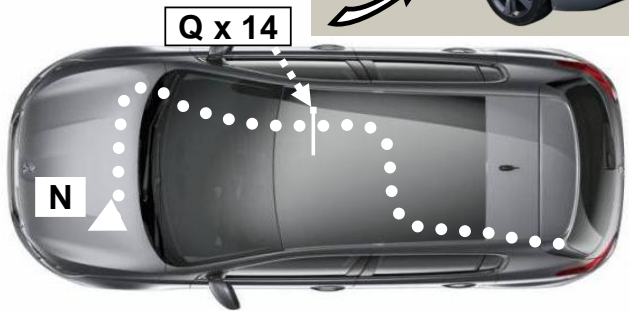

36

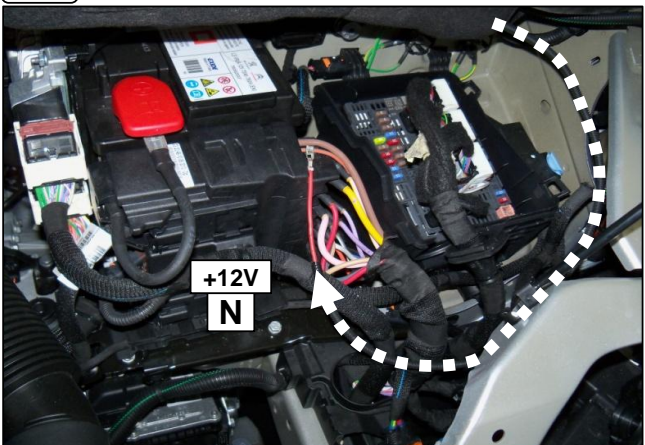

33

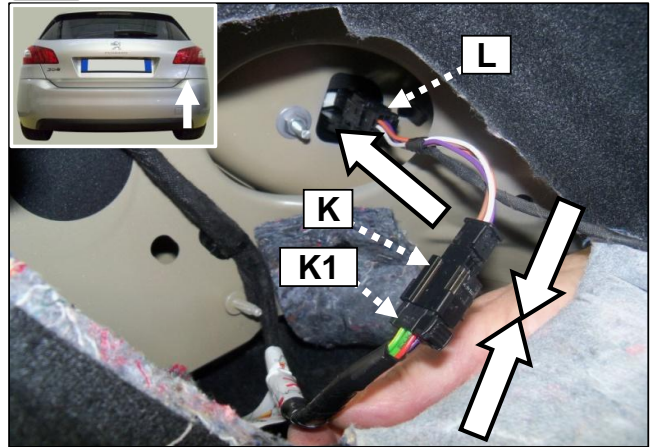

35

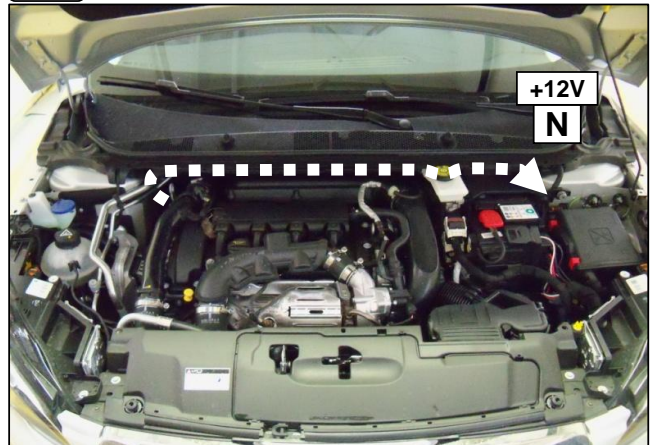

37

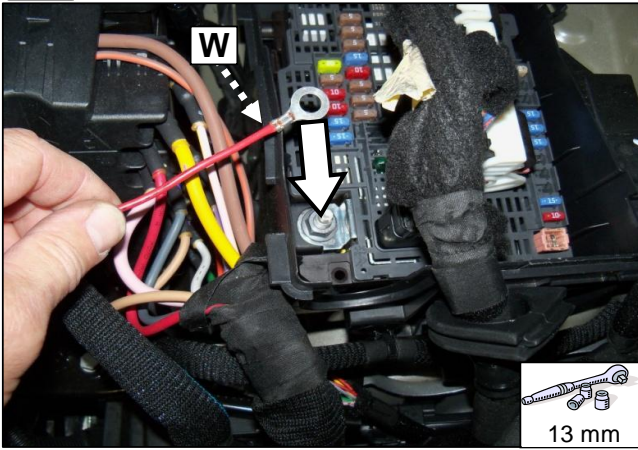

38

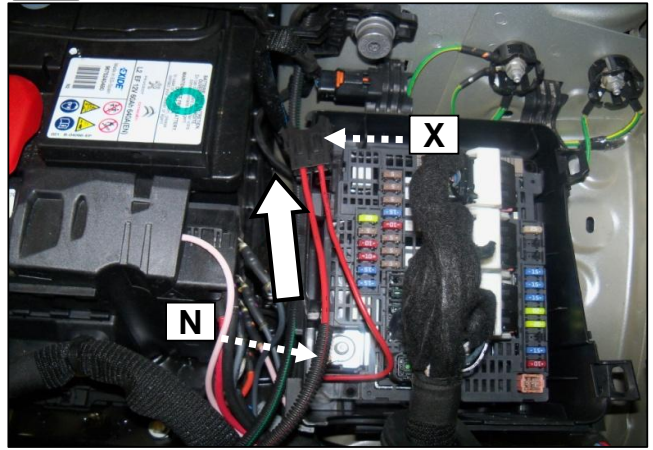

39

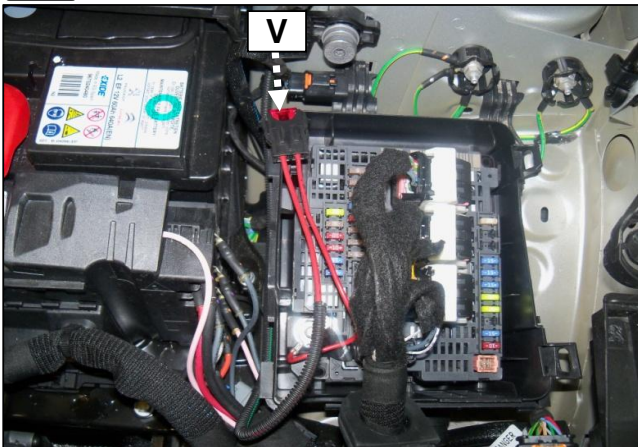

40

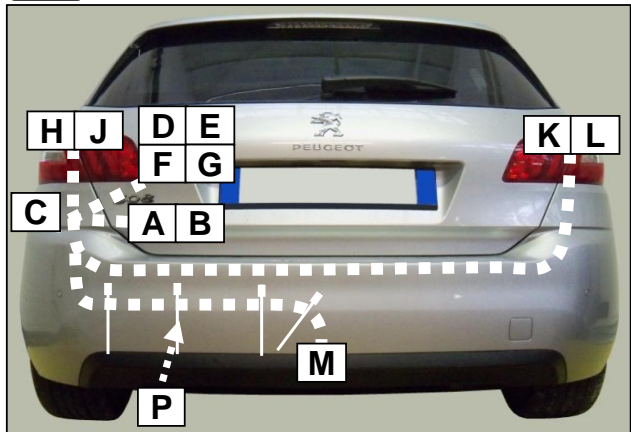

41

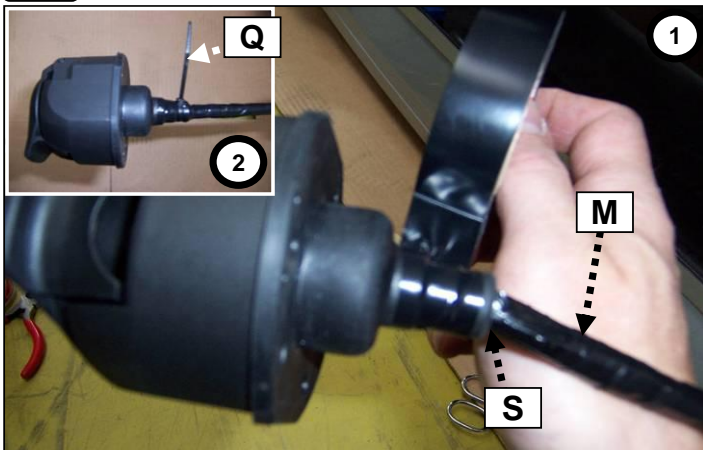

42

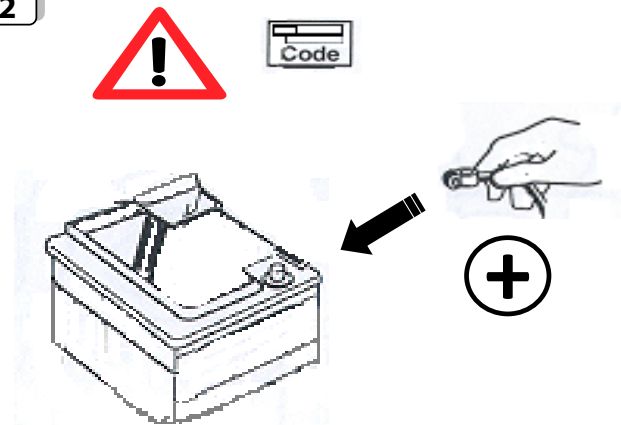

43

- (F) Contrôler les fonctions
- (G) Check functions
- (D) Funktionen kontrollieren
- (N) Controllere functies
- (IT) Controllare le funzioni
- (E) Controlar las funciones
- (S) Kontrollera funktionerna
- (FI) Tarkista toiminnot
- (PL) Sprawdz funkcje
- (C) Ověřte funkce
- (D) Check funktionerne
- (N) Kontroler funksjonene
- (G) Ελεγχος των λειτουργιών



44



Lors du branchement de la remorque ,désactiver le système "RADAR DE RECU" au tableau de bord
When you connect the trailer, do remove the function "PARK ASSIST" on the dashboard

Tab. B

FR Connection de la prise	NL Contactdoos aansluiting	SE Anslutning kontaktdosa	CZ objímkový konektor
GB Socket connection	IT Allaccio zoccolo	FI Pistorasia liitäntä	DK Stikdåse forbindelse
DE Anschluss Steckdose	ES Conexión de la caja de enchufe	PL Polaczenie przez gniazdo	NO Tilkobling koblingsboks
			GR Υποδοχή σύνδεσης

	1 /L	2 /54G	3 /31	4 /R	5 /58R	6 /54	7 /58L	C
P max	21+5 W	21 W		21+5 W	40 W	63 W	40 W	
FR	Jaune	Bleu	Vert/Jaune	Vert	Marron	Rouge	Noir	Gris
GB	Yellow	Blue	Green/Yellow	Green	Brown	Red	Black	Grey
DE	Gelb	Blau	Grün/Gelb	Grün	Braun	Rot	Schwarz	Grau
NL	Geel	Blauw	Groen/Geel	Groen	Bruin	Rood	Zwart	Grijs
IT	Giallo	Blu	Verde/Giallo	Verde	Marrone	Rosso	Nero	Grigio
ES	Amarillo	Azul	Verde/Amarillo	Verde	Marron	Rojo	Negro	Gris
SE	Gul	Blå	Grön/Gul	Grön	Brun	Röd	Svart	Grå
FI	Keltainen	Sininen	Vihreä/Keltainen	Vihreä	Ruskea	Punainen	Musta	Harmaa
PL	Żółty	Niebieski	Zielony/Żółty	Zielony	Brązowy	Czerwony	Czarny	Szary
CZ	Žlutý	Modrá	Zelený/Žlutý	Zelený	Hnědý	Červený	Černý	Šedá
DK	Gul	Blå	Grøn/Gul	Grøn	Brun	Rød	Sort	Grå
NO	Gul	Blå	Grønn/Gul	Grønn	Brun	Rød	Svart	Grå
GR	κίτρινο	μπλε	πράσινο/κίτρινο	πράσινο	καφέ	κόκκινο	μαύρο	γκρι

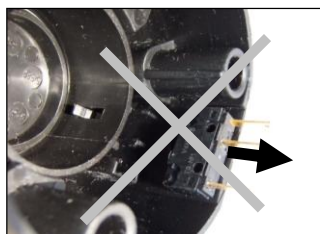

- FR** ne pas démonter le micro contacteur
- G** does not remove the micro switch
- DE** beseitigt nicht die Mikroschalter
- NL** neemt niet weg dat micro-schakelaar
- IT** non rimuovere il microinterruttore
- ES** no quita el micro interruptor
- SE** frångår inte mikrobrytare
- FI** ei poista mikrokkytkin
- PL** nie usuwa mikroprzełącznika
- CZ** neodstraní mikrosplínač
- D** fjerner ikke mikro switch
- N** fjerner ikke micro bryteren
- G** δεν αίρει την μικροδιακόπτη

